

Accessories

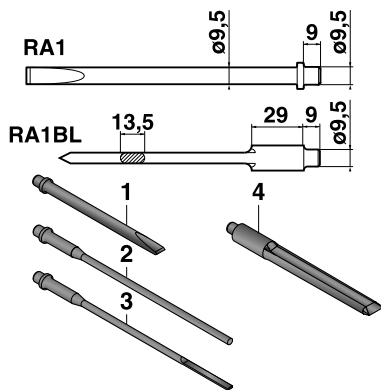
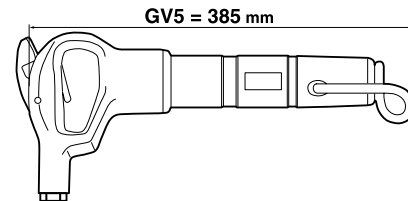
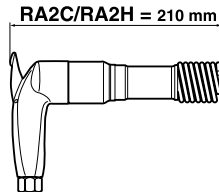
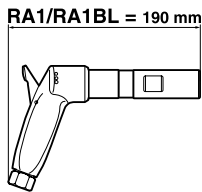

RA1 / RA1BL

ACCESSORIES INCLUDED

- 1/4" air hose nipple for 10 mm ID hose

PART NO.
615 705 006 0

OPTIONAL ACCESSORIES

Shank \varnothing 9.5 x 9 mm (3/8"x23/64")

ITEM

	RA1	RA1BL
1 Chisel, width 9 mm (23/64"), length 150 mm (5-29/32")	615 040 115 0	
2 Chisel, \varnothing 6 mm (15/64"), length 250 mm (9-27/32")	615 804 437 0	
3 Flat chisel 3 mm (1/8"), length 250 mm (9-27/32")	615 804 438 0	
4 Chisel thickness 6 mm (15/64"), length 145 mm (5-45/64")		615 041 114 0
4 Chisel thickness 6 mm (15/64"), length 200 mm (7-7/8")		615 041 120 0

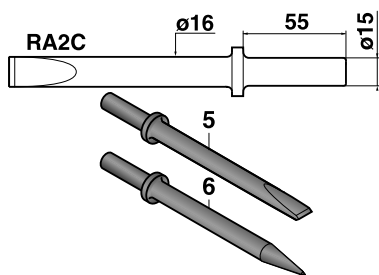

RA2C / RA2H

ACCESSORIES INCLUDED

- 1/4" air hose nipple for 10 mm ID hose

PART NO.
615 705 006 0

OPTIONAL ACCESSORIES

Shank 126 - \varnothing 15 x 55 mm (19/32"x2-11/64")

ITEM

	RA2C
5 Chisel, width 16 mm (5/8"), length 185 mm (7-9/32")	615 045 118 0
5 Chisel, width 16 mm (5/8"), length 250 mm (9-27/32")	615 804 088 0
6 Pick, length 185 mm (7-9/32")	615 045 218 0

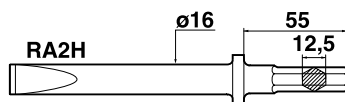

Shank 122 - Hex. 12.5 x 55 mm (8/16"x2-11/64")

ITEM

	RA2H
7 Chisel, width 16 mm (5/8"), length 185 mm (7-9/32")	615 046 118 0
7 Chisel, width 16 mm (5/8"), length 250 mm (9-27/32")	615 804 089 0
7 Chisel, width 16 mm (5/8"), length 310 mm (12-13/64")	615 804 431 0
7 Chisel, width 16 mm (5/8"), length 500 mm (19-11/16")	615 804 090 0
7 Chisel, width 16 mm (5/8"), length 1000 mm (29-3/8")	615 804 091 0
8 Chisel*, width 24 mm (15/16"), length 310 mm (12-13/64")	615 804 440 0*
8 Chisel*, width 50 mm (1-31/32"), length 250 mm (9-27/32")	615 804 421 0*

* Supplied with retaining spring 615 690 089 0 (former TR0289)

9 Blank tool, length 175 mm (6-57/64")	615 046 017 0
9 Blank tool, length 240 mm (9-29/64")	615 046 024 0
10 Pick, length 185 mm (7-9/32")	615 046 218 0
10 Pick, length 250 mm (9-27/32")	615 804 092 0
11 Blade cutter, length 200 mm (7-7/8")	615 046 920 0

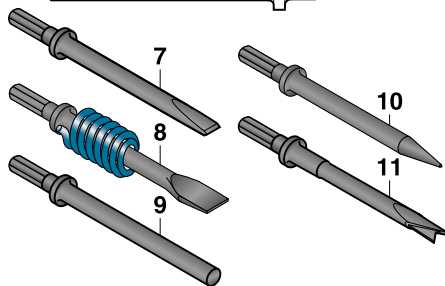

GV5

OPTIONAL ACCESSORIES

Hex. shank 19.2 x 50 mm (3/4"x1-31/32")

ITEM

	GV5
12 Chisel, width 19 mm (3/4"), length 300 mm (11-15/16")	615 804 095 0
12 Chisel, width 19 mm (3/4"), length 500 mm (19-11/16")	615 804 096 0
13 Pick, length 300 mm (11-15/16")	615 804 093 0
13 Pick, length 500 mm (19-11/16")	615 804 094 0
14 Scraper, width 60 mm (2-23/64"), length 250 mm (9-27/32")	615 804 097 0

Lou Zampini & Associates

2 Douglas Pike, Rt. 7
Smithfield, RI 02917

1 800 353 4676

FAX 1 401 679 0165

Riveting hammers, chisel scalers and pneumatic hammer



A

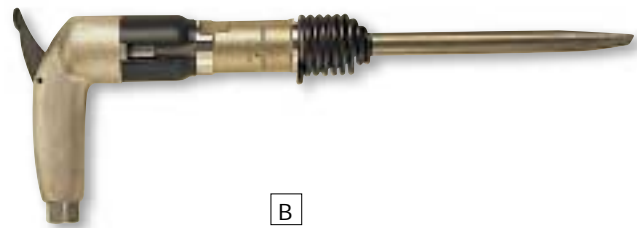

B



C



PICTURE REF	MODEL	PART NUMBER	BORE	STROKE	SHANK	BLOWS PER MINUTE	WEIGHT		AIR CONSUMPTION AT FREE SPEED		AIR INLET THREAD	HOSE INT. Ø
			mm	mm		Blows/min.	kg	lb.	l/s	cfm	inch	mm
RIVETING HAMMERS AND CHISEL SCALERS												
A	RA1	615 174 0180	13	45	Round	4000	1.1	24	3	7.0	1/4	10
A	RA1 BL	615 174 0190	13	45	Flatnosed	4000	1.1	24	3	7.0	1/4	10
B	RA2C	615 174 0200	18	58	126	3500	20	44	4.6	9.7	1/4	10
B	RA2H	615 174 0210	18	58	122	3500	20	44	4.6	9.7	1/4	10
PNEUMATIC HAMMER												
C	GV5	615 174 0170	28	525	19x50	2400	5.1	112	8.3	17.6	1/2	13