



Desoutter ™

## Fastening Tools



**Lou Zampini & Associates**  
2 Douglas Pike, Rt. 7  
Smithfield, RI 02917  
1 800 353 4676  
FAX 1 401 679 0165

# Safety Instructions

## General Safety Instructions for the Operation of Power Tools

The goal of Desoutter is to produce tools that help the operator work safely and efficiently.

The most important safety device for this or any other tool is the operator. Care and good judgement are the best protection against injury.

All possible hazards cannot be covered here, but we have tried to highlight some of the important ones.

Individuals should look for and obey Caution, Warning and Danger signs placed on tools, and displayed in the workplace. Operators should read and follow safety instructions packed with each tool. For a copy of these instructions, contact your local Desoutter representative.

Learn how each tool works. Even if you have previously used similar tools, carefully check out each tool before you use it. Get the 'feel' of it and know its capabilities, limitations, potential hazards, how it operates and how it stops.

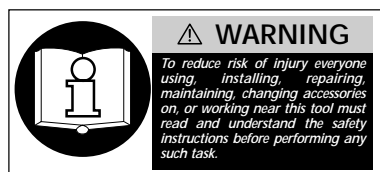

All tools are designed to operate at a line pressure of 6.3 bar +/- 0.15bar in accordance with ISO2787.

Sound levels +/- 3dB(A)\* measured in accordance with CAGI-PNEUROP test code or PNEUROP PN8NTC1.2. Vibration values\* measured in accordance with ISO 8662.

\*These declared values were obtained by laboratory testing in compliance with stated standards and are not adequate for risk assessments. Values measured in individual work places may be higher than the declared values. The actual exposure values and risk of harm experienced by an individual are unique and depend upon the way the user works, the workpiece and the work station design, as well as upon the exposure time and the physical condition of the user. We Desoutter cannot be held liable for the consequences of using declared values, instead of values reflecting the actual exposure, in an individual risk assessment in a work place situation over which we have no control.

Tools are CE marked to comply with European Machinery Directive.

Specifications subject to change without prior notice.

Further occupational health and safety information can be obtained from the following web sites <http://www.osha.gov> (USA) <http://europe.osha.eu.int> (Europe).



### Compressed Air Hazards

- Air under pressure can cause injury. Never point an air hose at yourself or anyone else. Never blow your clothes free of dust with compressed air. Always direct exhaust air away from yourself and others in the work area.
- Always check for damaged or loose hoses and fittings before using an air tool, and replace if necessary. Whipping hoses can cause serious injury.
- Disconnect the tool from the air supply when not in use, before changing accessories, setting the torque, or when making repairs.
- Do not exceed rated air pressure to increase the output of the tool. This could cause injury and shorten tool life.
- Do not assemble quick coupler on the tool. Vibration can cause breakage resulting in a whipping air hose. Instead, use quick couplers on the end of a short leader hose.
- When universal twist couplings are used, lock pins must be installed to prevent accidental hose disconnection.
- Air tools are not intended for use in explosive atmospheres and are not insulated for contact with electric power sources.



### Projectile Hazards

- Always wear impact resistant eye and face protection when involved with or near the operation or repair of tools.



### Breathing Hazards

- Proper breathing protection must be worn when working with materials, which produce airborne particles.



### Noise Hazards

- Hearing loss can result from prolonged exposure to excessive sound levels.
- Use hearing protection as recommended by your employer or Occupational Health and Safety Regulations.



### Vibration Hazards

- Repetitive work motions, awkward positions, and exposure to vibration may be harmful to your hands and arms.
- If numbness, tingling, pain or whitening of the skin occurs, stop using tool and consult a physician.



### Entanglement Hazards

- To reduce the risk of injury from entanglement, do not wear loose clothing when using rotating accessories.



### Additional Hazards

- Slip/Trip/Fall is a major cause of serious injury or death. Beware of excessive hose/cord left on the walking or work surface.
- Operators and maintenance personnel must be physically fit to perform job tasks, and handle the bulk, weight and power of the tool.
- Deburring tools should be used to reduce the risk of cuts and abrasions due to burrs.
- Wear gloves to protect hands from sharp edges.

# Safety Instructions and Contents

## Specific Safety Instructions for Power Tool Groups

In addition to the General Safety Instructions, the following are safety instructions and warnings that apply to the safe operation of specific power tool groups.



### Impulse Wrenches

- Never use hand sockets. Use only impact sockets in good condition. Sockets in poor condition reduce impact power and could also shatter, resulting in personal injury.
- When using a universal joint, never operate the tool off the work. It may run too fast and cause the joint to be thrown from the tool.
- Always use the simplest hook up possible. Long springy extension bars and adapters absorb impact power and could break loose resulting in personal injury. Instead, use deep sockets wherever possible.



### Angle Wrenches

- Never use hand sockets. Use only power drive sockets.
- To reduce the risk of injury, always support the handle securely in the direction opposite of the spindle rotation to minimize torque reaction.



### Screwdrivers

- Specific instructions/warnings affecting this group of tools are contained in product-specific documents accompanying each product.



### Accessories

- Always use accessories of correct size and design for the tool. Tool and accessories must not be modified in any way.
- Never use a tool without the proper accessory retainer.

## Contents

Safety Instructions ..... *page 2*

Tool Selection..... *page 4*

Ergonomics ..... *page 6*

Modularity ..... *page 7*

Tool Types and Torque Ranges..... *page 10*

Product Range ..... *page 13*

Accessories..... *page 28*









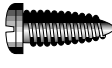

Other Products ..... *page 35*

# Tool Selection

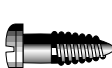
## Criteria

- Type of Fastener/Component
- Joint Integrity
- Torque Required
- Tool Orientation and Operator Reference
- Productivity
- Access

### Type of Fastener/Component

Fastener/Component		Recommended Tool Type
Machine Screw/Nut		Shut Off/Impulse/Direct Drive
Thread Rolling/Forming		Shut Off/HLT/Impulse
Self Tapping		Non Shut Off/HLT/Direct Drive
Self Tapping in Plastic/ Thin Materials		Shut Off/HLT
Self Drilling		Non Shut Off/HLT/Direct Drive
Wood Screws		Non Shut Off/Direct Drive
Screws with Adhesive		HLT/Non Shut Off/Impulse
Self Lock Nuts		HLT/Non Shut Off/Impulse
Misaligned Holes		HLT
Variable Size Holes		HLT
Fragile Components		HLT/Low Voltage Screwdrivers

### Joint Integrity

Average	High			Excellent
Direct Drive Impact	Non Shut Off	Impulse	Shut Off HLT	Shut Off and FAS
				DC Brushless Systems

# Tool Selection

## Fastener Torque Values

ISO	MACHINE SCREWS					THREAD FORMING/ ROLLING SCREWS
	4.6	5.8	8.8	10.9	12.9	8.8
THREAD SIZE	RECOMMENDED TORQUE (Nm)					RECOMMENDED TORQUE (Nm)
M1.6	0.07	0.12	0.19	-	-	-
M2	0.15	0.24	0.38	-	-	0.5
M2.2	0.19	0.31	0.51	-	-	-
M2.5	0.28	0.48	0.77	-	-	-
M3	0.51	0.85	1.4	1.9	2.3	1.4
M3.5	0.8	1.34	2.2	3.0	3.6	-
M4	1.2	2.0	3.2	4.5	5.4	3.2
M5	2.4	4.0	6.4	9.0	10.7	6.5
M6	4.1	6.8	10.9	15.3	18.3	11
M8	9.8	16.3	26.1	36.8	44.1	26
M10	19.3	32.2	51.5	72	86.9	52
M12	33.6	56	90	126	151	91
M14	53	89	142	200	239	-
M16	82	136	218	307	368	-
M18	114	190	304	428	513	-
M20	160	266	426	598	718	-
M22	215	358	573	806	967	-

## SELF TAPPING/DRILLING SCREWS

THREAD SIZE	RECOMMENDED TORQUE (Nm)
ST2.2 (B2)	0.2
ST2.9 (B4)	1.0
ST3.5 (B6)	1.8
ST4.2 (B8)	2.9
ST4.8 (B10)	4.2
ST5.5 (B12)	6.7
ST6.3 (B14)	9.1

### Conversion Factors

Nm x 141.6 = oz in

Nm x 8.851 = in lb

Nm x 0.73756 = ft lb

Nm x 0.102 = kgf m/kpm

Nm x 10.2 = kgf cm

*Torque figures should be used as a guide only  
Table assumes fasteners are new, lightly lubricated and of a standard finish  
For lock nuts with a nylon insert, +10%*

## Tool Orientation and Operator Preference



## Productivity

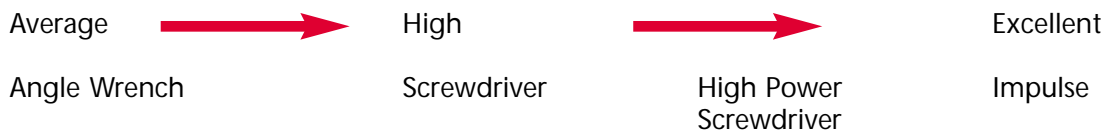

## Access



# Ergonomics

## The Benefits of Desoutter Ergosense to You

- Greater operator comfort
- Reduced operator fatigue
- Reduced handling times
- Reduced sickness
- Lower recruitment costs
- Lower employee liability costs
- Greater Productivity
- Improved Quality
- Improved Profitability



For further information on Ergonomics and Workplace Design ask for Desoutter publication LT198

## Cost Benefits of Desoutter Tools

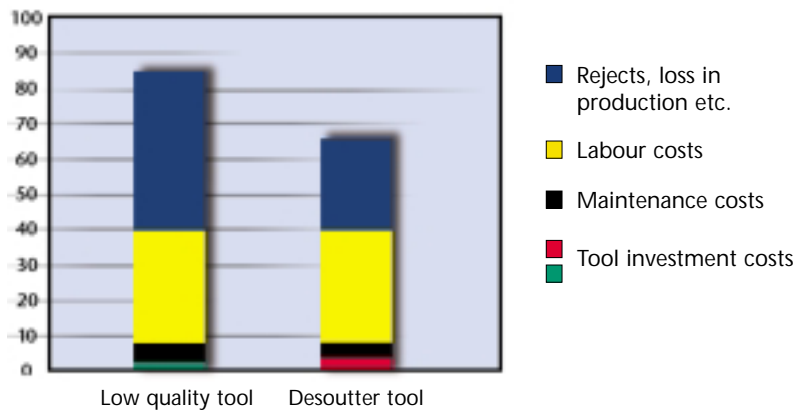

## Desoutter Ergosense in Practice

- Lightweight
- Short Length
- Light Start Load

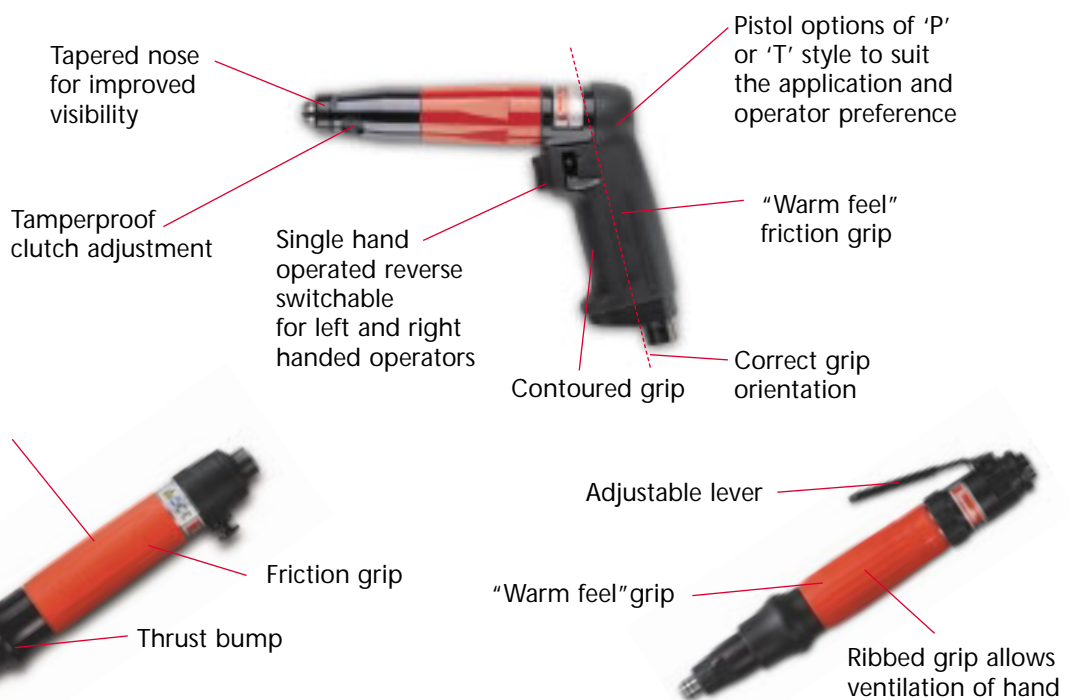

# Modularity

The Desoutter Modular SB, SC and SD Screwdriver ranges have been developed to provide our customers with flexibility whilst minimising the risk of tooling investment.

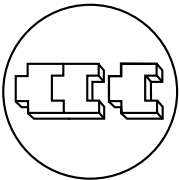

**Modularity = Flexibility = Productivity = Cost Reduction = Profit**

## Tool Selection

More options through modules to ensure the right tool is used for the application or the operator preference is met to increase productivity.

## Servicing

By replacing complete modules, tools can be returned to

production with a minimum of down time. Modules can then be serviced using service kits reducing the overall repair, tool and spare part stock costs.

## Changes in Production

A change in the product being assembled or the work flow may require new tools. A modular

design enables existing tools to be modified quickly and at a minimum cost.

## Upgrades

New developments can be incorporated on existing tools by replacing the relevant module.



# Modularity

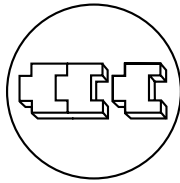

## SB Series

CLUTCH COVER  
TREADED NOSE  
(M20X1.0LH) WITH  
THRUST BUMP  
443833



CLUTCH COVER  
443623



CLUTCH COVER  
TREADED NOSE  
(M20X1.0LH)  
WITHOUT  
THRUST BUMP  
443843



S4Q  
CLUTCH 1/4"  
STANDARD  
443133



S4QD  
CLUTCH 1/4"  
DOUBLE  
ENDED  
443143



1600  
GEAR BOX  
443123



1100  
GEAR BOX  
443113



750  
GEAR BOX  
443103



500  
GEAR BOX  
443873



SB  
MOTOR CASE  
443093



AB  
CONTROL TOP  
BUTTON REVERSE  
443083



AR  
CONTROL TOP  
ROTARY REVERSE  
443073

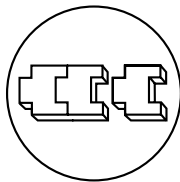

## SBP Series

1600/2300-S4Q  
CLUTCH 1/4"  
443133



550/1100-S4Q  
CLUTCH 1/4"  
462113



1600/2300-R4Q  
CLUTCH 1/4"  
462123



550/1100-R4Q  
CLUTCH 1/4"  
462133



2300  
GEAR BOX  
443123



1600  
GEAR BOX  
443113



1100  
GEAR BOX  
443103



550  
GEAR BOX  
462143



GEAR CASE  
462763



PISTOL GRIP ASSEMBLY  
462173  
TRIGGER ASSEMBLY  
462183  
AIR INLET ASSEMBLY  
462193  
VALVE ASSEMBLY  
462163  
MOTOR ASSEMBLY  
462153



CLUTCH COVER  
TREADED NOSE  
(M20X1.0LH)  
443843





# Modularity

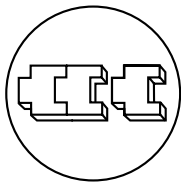

## SC Series

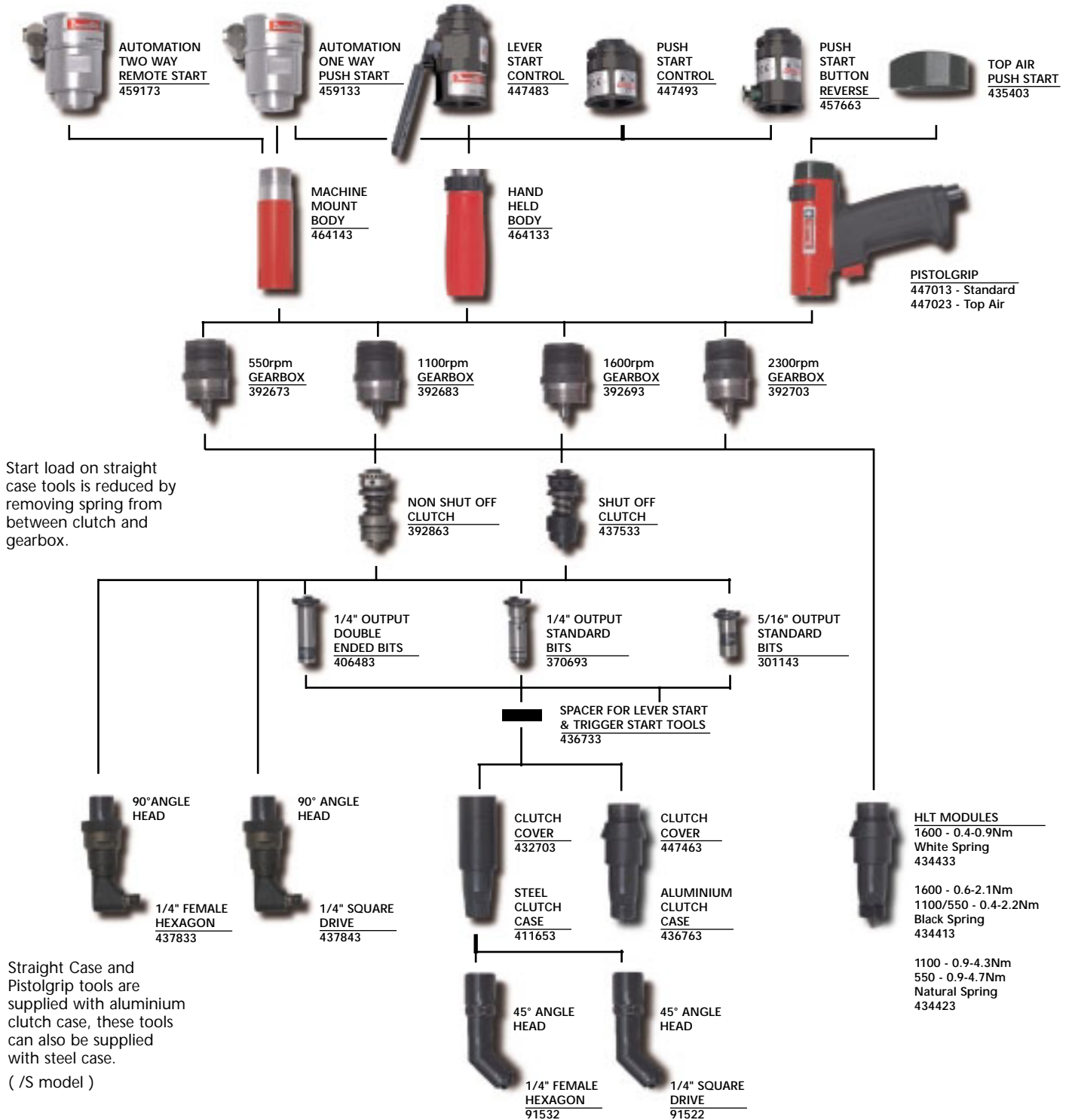







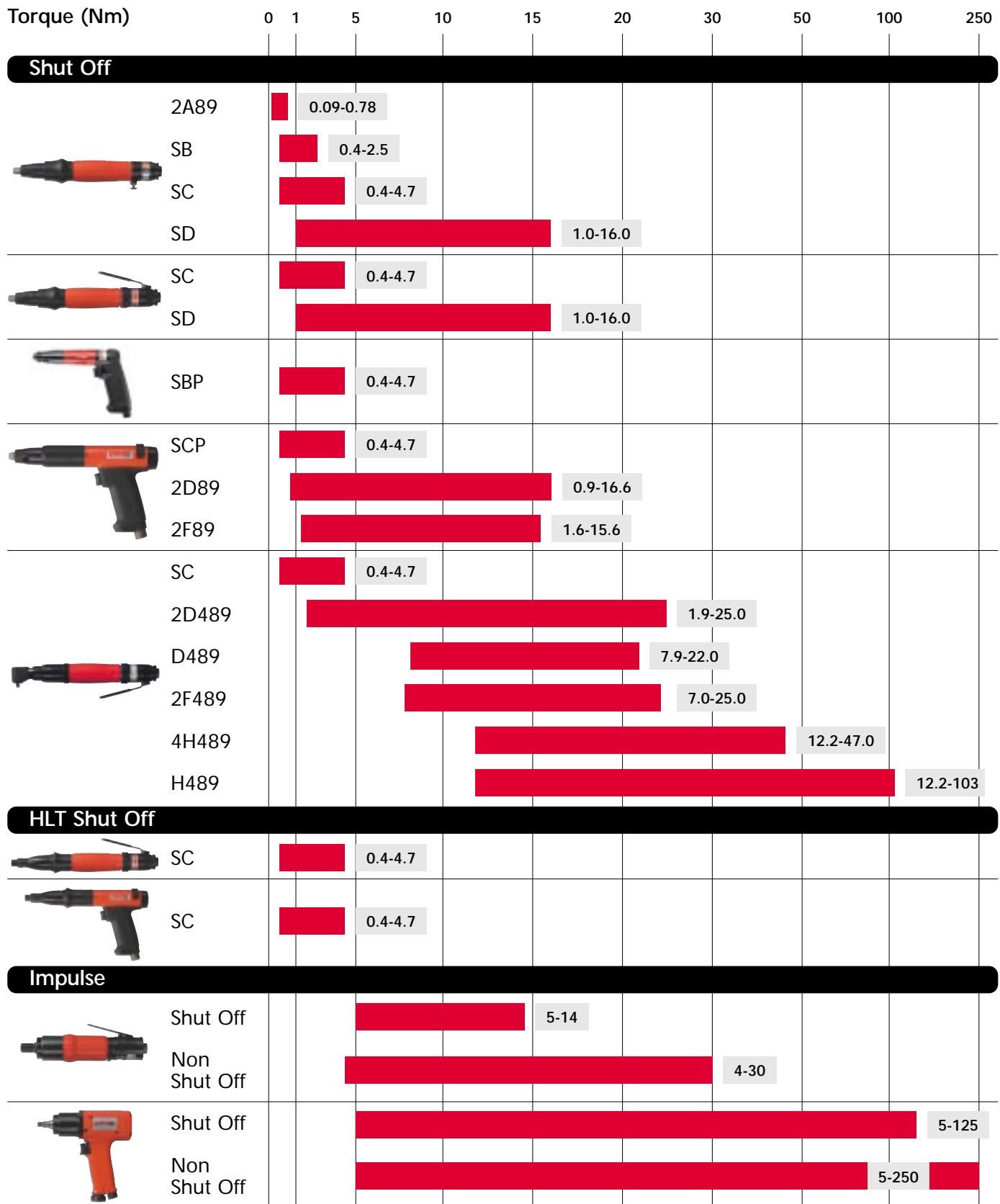

Start load on straight case tools is reduced by removing spring from between clutch and gearbox.

Straight Case and Pistolgrip tools are supplied with aluminium clutch case, these tools can also be supplied with steel case.  
( /S model )

# Tool Types and Torque Ranges



# Tool Types and Torque Ranges

Torque (Nm)		0	1	5	10	15	20	30	50	100	250	
<b>Non Shut Off</b>												
	SC	0.4-4.4										
	SD	1.0-10.0										
	SC	0.4-4.4										
	SD	1.0-10.0										
	SBP	0.4-4.4										
	SCP	0.4-4.4										
	2D8	0.6-10.0										
	2F8	0.6-15.0										
	SC	0.4-4.4										
	2D8	0.6-6.8										
	2D48	7.7-14.4										
<b>Direct Drive</b>												
	2D2	0.3-14.0										
	2F2	1.2-18.0										
	2D472	1.2-12.6										
	2D4201	1.5-15.4										
	H410	3-105										
<b>Electric Screwdrivers</b>												
	SME	0.5-3.9										
	S4	0.08-0.72										
	S5	0.4-2.3										
	S5	0.36-1.9										

# Screwdriver Torque Ranges

Torque output of the Desoutter range of shut off and non shut off screwdrivers is controlled by the type of spring in the clutch assembly.

The overall torque range, together with that of the factory fitted spring on a soft joint to ISO5393 are listed in the tables on the following pages. The chart below provides an indication of the torque ranges for the optional colour coded clutch springs together with their respective part numbers (some are included with certain tools). As a general rule, the tool should be fitted with a spring which ensures the torque required falls within 20 to 80% of the operating range.

Please note that the torque range of specific speed tools may alter slightly from that shown below and for this reason the chart should be used as a guide only.

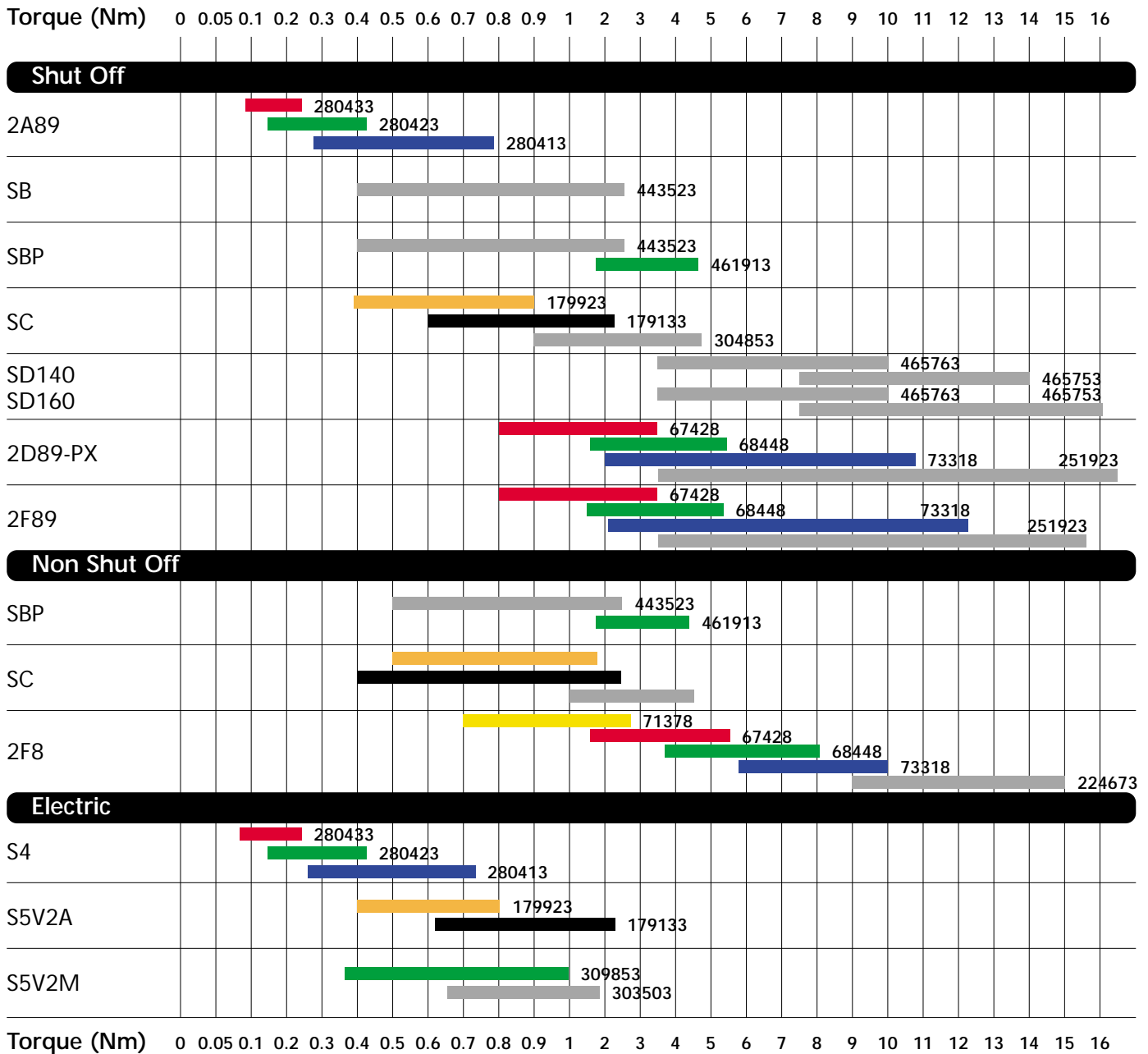

# Product Range



## Screwdrivers

Shut Off – Push Start .....	page 14
Shut Off – Lever Start .....	page 15
Shut Off – Pistol Grip .....	page 16
Shut Off – HLT .....	page 17
Shut Off – Fastening Assurance System ..	page 18
Non Shut Off – Push Start .....	page 20
Non Shut Off – Lever Start .....	page 20
Non Shut Off – Pistol Grip .....	page 21
Direct Drive – Pistol Grip .....	page 22
Automatic Reverse .....	page 22
Electric – Mains Voltage .....	page 26
Electric – Low Voltage .....	page 27



## Angle Head Tools

Shut Off .....	page 24
Non Shut Off .....	page 25
Direct Drive .....	page 25



## Impulse Tools

Non Shut Off .....	page 23
Shut Off .....	page 23



## Screwfeeders and Torque Motors

Summary .....	page 34
---------------	---------



## Impact Wrenches Chicago Pneumatic

For full details of the Chicago Pneumatic range of Impact Wrenches ask your local sales contact for details.

# Screwdrivers – Shut Off – Push Start



PICTURE REF	TOOL TYPE	PART NUMBER	FREE SPEED	OUTPUT <sup>(1)</sup>	TORQUE RANGE	FITTED SPRING	LENGTH	WEIGHT	AIR FLOW	AIR HOSE BORE	AIR INLET <sup>(2)</sup>	SOUND LEVEL	VIBRATION
			r/min	hex	Nm	Nm	mm	kg	l/s	mm	BSP	dB(A)	ms <sup>-2</sup>
A	2A89-A-1300	1225434	1300	3mm	0.09-0.56	0.15-0.43	178	0.21	2.2	3	M5	64	<2.5
A	2A89-A-700	1225514	700	3mm	0.09-0.75	0.15-0.43	178	0.21	2.2	3	M5	64	<2.5
A	2A89-A-400	1225694	400	3mm	0.09-0.78	0.15-0.43	178	0.21	2.2	3	M5	64	<2.5
A	2A89-A-1300	1223154	1300	1/4"	0.09-0.56	0.15-0.43	178	0.21	2.2	3	M5	64	<2.5
A	2A89-A-700	1223234	700	1/4"	0.09-0.75	0.15-0.43	178	0.21	2.2	3	M5	64	<2.5
A	2A89-A-400	1223314	400	1/4"	0.09-0.78	0.15-0.43	178	0.21	2.2	3	M5	64	<2.5
B	SB011-AB1600-S4Q	1460644	1600	1/4"	0.4-1.1	0.4-1.1	197	0.42	4.1	5	1/8"	69	<2.5
B	SB015-AB1100-S4Q	1460634	1100	1/4"	0.4-1.5	0.4-1.5	197	0.42	4.1	5	1/8"	69	<2.5
B	SB025-AB750-S4Q	1460624	750	1/4"	0.4-2.5	0.4-2.5	197	0.42	4.1	5	1/8"	69	<2.5
B	SB025-AB500-S4Q	1460684	500	1/4"	0.4-2.5	0.4-2.5	197	0.42	4.1	5	1/8"	69	<2.5
C	SB011-AR1600-S4Q	1460524	1600	1/4"	0.4-1.1	0.4-1.1	197	0.42	4.1	5	1/8"	69	<2.5
C	SB015-AR1100-S4Q	1460514	1100	1/4"	0.4-1.5	0.4-1.5	197	0.42	4.1	5	1/8"	69	<2.5
C	SB025-AR750-S4Q	1460504	750	1/4"	0.4-2.5	0.4-2.5	197	0.42	4.1	5	1/8"	69	<2.5
C	SB025-AR500-S4Q	1460564	500	1/4"	0.4-2.5	0.4-2.5	197	0.42	4.1	5	1/8"	69	<2.5
D	SC021-AB2300-S4Q	1461854	2300	1/4"	0.4-2.1	0.4-0.9	250	0.61	6.5	6	1/8"	75	<2.5
D	SC021-AB1600-S4Q	1461864	1600	1/4"	0.4-2.1	0.6-2.1	250	0.61	6.5	6	1/8"	75	<2.5
D	SC043-AB1100-S4Q	1461874	1100	1/4"	0.4-4.3	0.9-4.3	250	0.61	6.5	6	1/8"	75	<2.5
D	SC047-AB550-S4Q	1461884	550	1/4"	0.4-4.7	0.9-4.7	250	0.61	6.5	6	1/8"	75	<2.5
E	SC021-A2300-S4Q	1456574	2300	1/4"	0.4-2.1	0.4-0.9	250	0.61	6.5	6	1/8"	73	<2.5
E	SC021-A1600-S4Q	1456584	1600	1/4"	0.4-2.1	0.6-2.1	250	0.61	6.5	6	1/8"	73	<2.5
E	SC043-A1100-S4Q	1456594	1100	1/4"	0.4-4.3	0.9-4.3	250	0.61	6.5	6	1/8"	73	<2.5
E	SC047-A550-S4Q	1456604	550	1/4"	0.4-4.7	0.9-4.7	250	0.61	6.5	6	1/8"	73	<2.5
F	SD023-AB3500-S4Q	1462834	3500	1/4"	1.0-2.3	1.0-2.3	227	0.73	8.7	10	1/4"	73	<2.5
F	SD035-AB2200-S4Q	1462824	2200	1/4"	1.0-3.5	1.0-3.5	227	0.73	8.7	10	1/4"	73	<2.5
F	SD055-AB1470-S4Q	1462814	1470	1/4"	2.0-5.5	2.0-5.5	253	0.89	8.7	10	1/4"	73	<2.5
F	SD075-AB1100-S4Q	1462804	1100	1/4"	2.5-7.5	2.5-7.5	253	0.89	8.7	10	1/4"	73	<2.5
F	SD100-AB820-S4Q	1462794	820	1/4"	3.5-10.0	3.5-10.0	253	0.89	8.7	10	1/4"	73	<2.5
F	SD140-AB510-S4Q	1462784	510	1/4"	3.5-14.0	3.5-10.0	253	0.89	8.7	10	1/4"	73	<2.5
F	SD160-AB320-S4Q	1462774	320	1/4"	3.5-16.0	3.5-10.0	253	0.89	8.7	10	1/4"	73	<2.5
G	SD023-AR3500-S4Q	1462764	3500	1/4"	1.0-2.3	1.0-2.3	227	0.73	8.7	10	1/4"	73	<2.5
G	SD035-AR2200-S4Q	1462754	2200	1/4"	1.0-3.5	1.0-3.5	227	0.73	8.7	10	1/4"	73	<2.5
G	SD055-AR1470-S4Q	1462744	1470	1/4"	2.0-5.5	2.0-5.5	253	0.89	8.7	10	1/4"	73	<2.5
G	SD075-AR1100-S4Q	1462734	1100	1/4"	2.5-7.5	2.5-7.5	253	0.89	8.7	10	1/4"	73	<2.5
G	SD100-AR820-S4Q	1462724	820	1/4"	3.5-10.0	3.5-10.0	253	0.89	8.7	10	1/4"	73	<2.5
G	SD140-AR510-S4Q	1462714	510	1/4"	3.5-14.0	3.5-10.0	253	0.89	8.7	10	1/4"	73	<2.5
G	SD160-AR320-S4Q	1462704	320	1/4"	3.5-16.0	3.5-10.0	253	0.89	8.7	10	1/4"	73	<2.5

<sup>(1)</sup> Types D to E, 5/16" hex bit holder optional. Types B to C, 1/4" double ended bit holder optional

<sup>(2)</sup> Types B to G, NPT optional

A side handle should be fitted for torques over 4Nm (SD tools are supplied with a side handle as standard)

# Screwdrivers – Shut Off – Lever Start

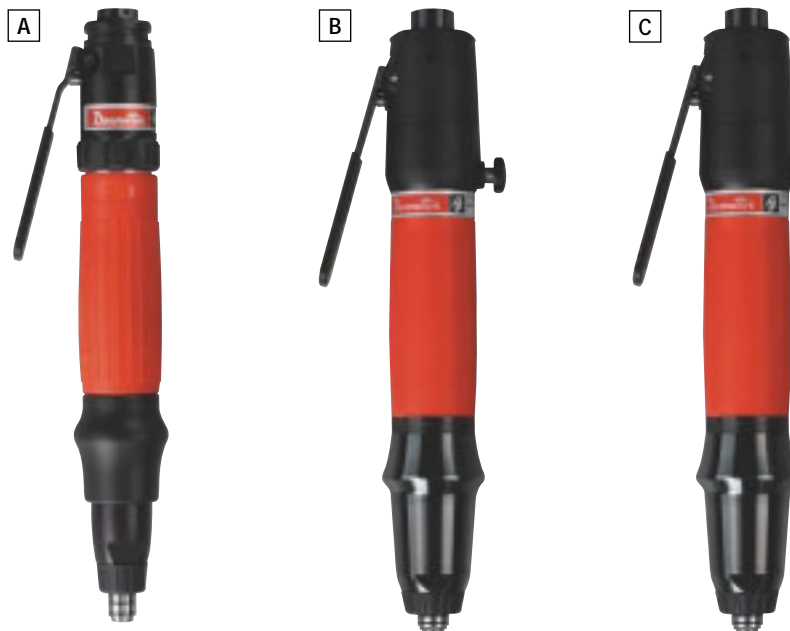

PICTURE REF	TOOL TYPE	PART NUMBER	FREE SPEED	OUTPUT <sup>(1)</sup>	TORQUE RANGE	FITTED SPRING	LENGTH	WEIGHT	AIR FLOW	AIR HOSE BORE	AIR INLET <sup>(2)</sup>	SOUND LEVEL	VIBRATION
			r/min	hex	Nm	Nm							
A	SC021-L2300-S4Q	1456654	2300	1/4"	0.4-2.1	0.4-0.9	275	0.68	6.5	6	1/8"	73	<2.5
A	SC021-L1600-S4Q	1456664	1600	1/4"	0.4-2.1	0.6-2.1	275	0.68	6.5	6	1/8"	73	<2.5
A	SC043-L1100-S4Q	1456674	1100	1/4"	0.4-4.3	0.9-4.3	275	0.68	6.5	6	1/8"	73	<2.5
A	SC047-L550-S4Q	1456684	550	1/4"	0.4-4.7	0.9-4.7	275	0.68	6.5	6	1/8"	73	<2.5
B	SD023-LB3500-S4Q	1463094	3500	1/4"	1.0-2.3	1.0-2.3	252	0.76	8.7	10	1/4"	73	<2.5
B	SD035-LB2200-S4Q	1463084	2200	1/4"	1.0-3.5	1.0-3.5	252	0.76	8.7	10	1/4"	73	<2.5
B	SD055-LB1470-S4Q	1463074	1470	1/4"	2.0-5.5	2.0-5.5	278	0.92	8.7	10	1/4"	73	<2.5
B	SD075-LB1100-S4Q	1463064	1100	1/4"	2.5-7.5	2.5-7.5	278	0.92	8.7	10	1/4"	73	<2.5
B	SD100-LB820-S4Q	1463054	820	1/4"	3.5-10.0	3.5-10.0	278	0.92	8.7	10	1/4"	73	<2.5
B	SD140-LB510-S4Q	1463044	510	1/4"	3.5-14.0	3.5-10.0	278	0.92	8.7	10	1/4"	73	<2.5
B	SD160-LB320-S4Q	1463034	320	1/4"	3.5-16.0	3.5-10.0	278	0.92	8.7	10	1/4"	73	<2.5
C	SD023-LR3500-S4Q	1463024	3500	1/4"	1.0-2.3	1.0-2.3	252	0.76	8.7	10	1/4"	73	<2.5
C	SD035-LR2200-S4Q	1463014	2200	1/4"	1.0-3.5	1.0-3.5	252	0.76	8.7	10	1/4"	73	<2.5
C	SD055-LR1470-S4Q	1463004	1470	1/4"	2.0-5.5	2.0-5.5	278	0.92	8.7	10	1/4"	73	<2.5
C	SD075-LR1100-S4Q	1462994	1100	1/4"	2.5-7.5	2.5-7.5	278	0.92	8.7	10	1/4"	73	<2.5
C	SD100-LR820-S4Q	1462984	820	1/4"	3.5-10.0	3.5-10.0	278	0.92	8.7	10	1/4"	73	<2.5
C	SD140-LR510-S4Q	1462974	510	1/4"	3.5-14.0	3.5-10.0	278	0.92	8.7	10	1/4"	73	<2.5
C	SD160-LR320-S4Q	1462964	320	1/4"	3.5-16.0	3.5-10.0	278	0.92	8.7	10	1/4"	73	<2.5

<sup>(1)</sup> 5/16" hex bit holder optional for type A

<sup>(2)</sup> NPT optional

A side handle should be fitted for torques over 4Nm (SD tools are supplied with a side handle as standard)

# Screwdrivers – Shut Off – Pistol Grip



## PUSH AND TRIGGER START

PICTURE REF	TOOL TYPE	PART NUMBER	FREE SPEED	OUTPUT	TORQUE RANGE	FITTED SPRING	LENGTH	WEIGHT	AIR FLOW	AIR HOSE BORE	AIR INLET <sup>(2)</sup>	SOUND LEVEL	VIBRATION
			r/min	hex	Nm	Nm	mm	kg	l/s	mm	BSP	dB(A)	ms <sup>-2</sup>
A	SBP021-T2300-S4Q	1462144	2300	1/4"	0.4-2.1	0.4-2.1	182	0.82	6.5	6	1/8"	73	<2.5
A	SBP021-T1600-S4Q	1462154	1600	1/4"	0.4-2.1	0.4-2.1	182	0.82	6.5	6	1/8"	73	<2.5
A	SBP043-T1100-S4Q	1462164	1100	1/4"	0.4-4.3	1.8-4.3	182	0.82	6.5	6	1/8"	73	<2.5
A	SBP047-T550-S4Q	1462174	550	1/4"	0.4-4.7	1.8-4.7	182	0.82	6.5	6	1/8"	73	<2.5

## TRIGGER START

PICTURE REF	TOOL TYPE	PART NUMBER	FREE SPEED	OUTPUT <sup>(1)</sup>	TORQUE RANGE	FITTED SPRING	LENGTH	WEIGHT	AIR FLOW	AIR HOSE BORE	AIR INLET <sup>(2)</sup>	SOUND LEVEL	VIBRATION
			r/min	hex	Nm	Nm	mm	kg	l/s	mm	BSP	dB(A)	ms <sup>-2</sup>
B	SCP021-T2300-S4Q	1456734	2300	1/4"	0.4-2.1	0.4-0.9	228	0.86	6.5	6	1/8"	73	<2.5
B	SCP021-T1600-S4Q	1456744	1600	1/4"	0.4-2.1	0.6-2.1	228	0.86	6.5	6	1/8"	73	<2.5
B	SCP043-T1100-S4Q	1456754	1100	1/4"	0.4-4.3	0.9-4.3	228	0.86	6.5	6	1/8"	73	<2.5
B	SCP047-T550-S4Q	1456764	550	1/4"	0.4-4.7	0.9-4.7	228	0.86	6.5	6	1/8"	73	<2.5
C	SCPT021-A2300-S4Q	1458974	2300	1/4"	0.4-2.1	0.4-0.9	230	0.86	6.5	6	1/8"	73	<2.5
C	SCPT021-A1600-S4Q	1458934	1600	1/4"	0.4-2.1	0.6-2.1	230	0.86	6.5	6	1/8"	73	<2.5
C	SCPT043-A1100-S4Q	1458894	1100	1/4"	0.4-4.3	0.9-4.3	230	0.86	6.5	6	1/8"	73	<2.5
C	SCPT047-A550-S4Q	1458854	550	1/4"	0.4-4.7	0.9-4.7	230	0.86	6.5	6	1/8"	73	<2.5
D	2D89-PX-2200	1455874	2200	1/4"	0.9-3.6	0.9-3.5	227	1.2	8	10	1/4"	72	<2.5
D	2D89-PX-1500	1455854	1500	1/4"	0.9-4.5	0.9-3.5	240	1.2	8	10	1/4"	72	<2.5
D	2D89-PX-850	1455834	850	1/4"	1.5-6.8	1.5-6.6	240	1.2	8	10	1/4"	72	<2.5
D	2D89-PX-540	1455814	540	1/4"	1.5-10.7	2.0-10.7	240	1.2	8	10	1/4"	72	<2.5
D	2D89-PX-340	1455794	340	1/4"	3.6-16.6	3.6-16.6	252	1.2	8	10	1/4"	72	<2.5
E	2F89-PX-2200	1336914	2200	1/4"	1.9-5.1	0.9-3.5	223	1.3	9.4	10	1/4"	82	<2.5
E	2F89-PX-1100	1337144	1100	1/4"	1.8-9.0	1.8-5.4	245	1.4	9.4	10	1/4"	82	<2.5
E	2F89-PX-650	1337724	650	1/4"	1.6-12.3	1.6-5.4	245	1.4	9.4	10	1/4"	82	<2.5
E	2F89-PX-450	1337984	450	1/4"	1.6-11.9	1.6-5.4	245	1.4	9.4	10	1/4"	82	<2.5
E	2F89-PX-750	1337304	750	1/4"	3.5-14.0	3.5-14.0	257	1.5	9.4	10	1/4"	82	<2.5
E	2F89-PX-500	1337564	500	1/4"	3.5-15.6	3.5-15.6	257	1.5	9.4	10	1/4"	82	<2.5

<sup>(1)</sup> Types B, C, D and E, 5/16" hex bit holder optional

<sup>(2)</sup> NPT optional

<sup>(3)</sup> Types B and C are available with a steel nose

A side handle should be fitted for torques over 10Nm



# Screwdrivers – Shut Off HLT



PICTURE REF	TOOL TYPE	PART NUMBER	FREE SPEED	OUTPUT	TORQUE RANGE	FITTED SPRING	LENGTH	WEIGHT	AIR FLOW	AIR HOSE BORE	AIR INLET <sup>(1)</sup>	SOUND LEVEL	VIBRATION
			r/min	hex	Nm	Nm	mm	kg	l/s	mm	BSP	dB(A)	ms <sup>-2</sup>
A	SC009-L1600-HLT4M	1459644	1600	1/4"	0.4-0.9	0.4-0.9	286	0.79	7	6	1/8"	73	<2.5
A	SC021-L1600-HLT4M	1459614	1600	1/4"	0.6-2.1	0.6-2.1	286	0.79	7	6	1/8"	73	<2.5
A	SC022-L1100-HLT4M	1459654	1100	1/4"	0.4-2.2	0.4-2.2	286	0.79	7	6	1/8"	73	<2.5
A	SC022-L550-HLT4M	1459664	550	1/4"	0.4-2.2	0.4-2.2	286	0.79	7	6	1/8"	73	<2.5
A	SC043-L1100-HLT4M	1459624	1100	1/4"	0.9-4.3	0.9-4.3	286	0.79	7	6	1/8"	73	<2.5
A	SC047-L550-HLT4M	1459634	550	1/4"	0.9-4.7	0.9-4.7	286	0.79	7	6	1/8"	73	<2.5
B	SCP009-T1600-HLT4M	1459704	1600	1/4"	0.4-0.9	0.4-0.9	245	1.0	7	6	1/8"	73	<2.5
B	SCP021-T1600-HLT4M	1459714	1600	1/4"	0.6-2.1	0.6-2.1	245	1.0	7	6	1/8"	73	<2.5
B	SCP022-T1100-HLT4M	1459724	1100	1/4"	0.4-2.2	0.4-2.2	245	1.0	7	6	1/8"	73	<2.5
B	SCP043-T1100-HLT4M	1459734	1100	1/4"	0.9-4.3	0.9-4.3	245	1.0	7	6	1/8"	73	<2.5
B	SCP022-T550-HLT4M	1459744	550	1/4"	0.4-2.2	0.4-2.2	245	1.0	7	6	1/8"	73	<2.5
B	SCP047-T550-HLT4M	1459754	550	1/4"	0.9-4.7	0.9-4.7	245	1.0	7	6	1/8"	73	<2.5

<sup>(1)</sup> NPT optional

## TYPICAL HLT CYCLE

- 1 Tool starts to cut/form thread – direct drive
- 2 Thread is cut/formed, rundown continues – direct drive
- 3 Depth stop touches component, drive engages clutch
- 4 Final torque achieved, clutch operates and air supply is shut off

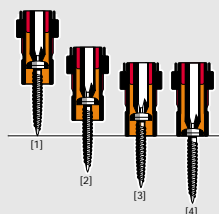

Depth stop changes tool from direct drive to clutch operation

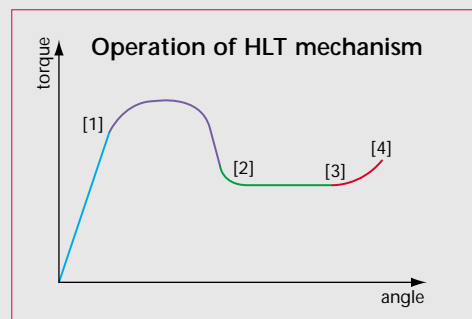

C



D



E

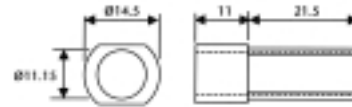

## DEPTH STOPS

PICTURE REF	PART NUMBER	LENGTH
		mm
C	440833	28
C	440843	48
C	440853	127

PICTURE REF	PART NUMBER	T	ØA
		mm	mm
D	440863*	5	25
D	440873	3	15

\* Supplied with tools

PICTURE REF	PART NUMBER	MATERIAL
E	432533	Steel
E	445623	Composite

# Screwdrivers – Shut Off – Fastening Assurance System



The Desoutter FAS2000 – Fastening Assurance System provides the ability to verify that all the fasteners in an assembly have been correctly fastened without the level of investment usually associated with assembly control systems and additional inspection.

By comparing the timing of pneumatic signals from a shut off screwdriver with set parameters, the fastening cycle can be monitored and output signals generated for OK and NOK assembly confirmation.

The output signals can then be combined to indicate that all the fasteners on the component have been tightened correctly.

The FAS2000 has been designed with the operator and engineer in mind and is easy to use and set up with a typical procedure comprising:

- Select measurement program.
- Rundown a number of OK screws and record data from the display.
- Enter parameters into the program via facia keypad.
- Select the run mode and the FAS2000 is now ready to use.

## Features

- Automatic measurement of fastener profile for rapid set up.
- 3 programs for different fastener profiles.
- Capacity for a maximum of 80 fasteners per program.
- OK and Not OK visual indicators for each fastener.
- Audible error warning for Not OK.
- 'Group Cycle Complete' visual indicator.
- Manual lockable reset switch.
- Password protection of parameters.
- 4 output sockets for interfacing with other equipment including inputs as well as output signals.
- EMC approved.

Coded error messages are shown on the LED display to quickly identify the problem with the assembly process. The messages include:

- Fastener already tightened.
- Clutch operated before minimum time.
- Clutch operated after maximum time.
- Trigger/Lever released at the same instant as the clutch operated.
- Trigger/Lever released before the clutch operated.
- Sensor failure.
- Too many fasteners tightened.

## OPERATING SEQUENCE

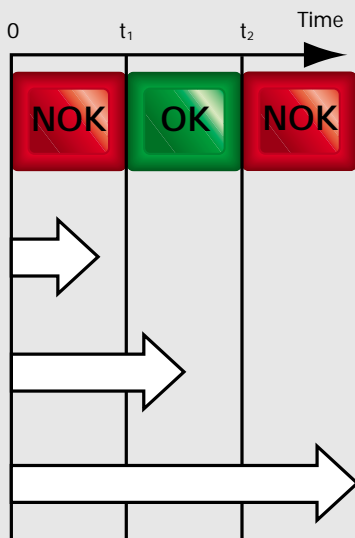

$t_1$  = Minimum time  
 $t_2$  = Maximum time

Clutch operated before minimum time, lever/trigger released before minimum time. Indicates crossed thread, screw too short, thread too short, too many washers.

Clutch operated within time limits – OK.

Clutch operated after maximum time. Screw too long, no thread in component, stripped thread, no washers on assembly.

# Screwdrivers – Shut Off – Fastening Assurance System

To make a complete system order the following items:

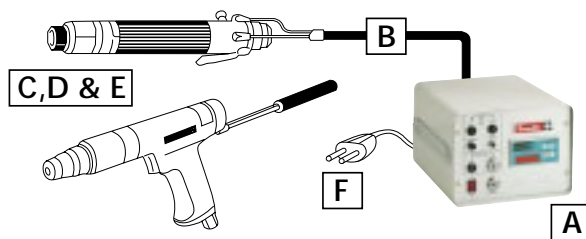

## FAS2000 CONTROLLER

PICTURE REF	DESCRIPTION	PART NUMBER	LENGTH	WIDTH	HEIGHT	WEIGHT
			mm	mm	mm	kg
A	FAS2000	1459424	260	220	150	4.5

Supply Voltage: AC 220-240 V, 50Hz & AC 110-120 V, 60Hz

## SENSOR ASSEMBLY

PICTURE REF	DESCRIPTION	PART NUMBER	LENGTH
			mm
B	Sensor Assembly	457203	2000
B	Sensor Assembly	457213	5000

## SCREWDRIVERS

PICTURE REF	TOOL TYPE	PART NUMBER	FREE SPEED	OUTPUT	TORQUE RANGE	FITTED SPRING	LENGTH	AIR FLOW	AIR HOSE BORE	AIR INLET	WEIGHT	SOUND LEVEL	VIBRATION LEVEL
			r/min	hex	Nm	Nm		mm	l/s	mm		BSP	kg
C	SCP021-T2300-FAS4Q	1461124	2300	1/4"	0.4-2.1	0.4-0.9	245	6.5	6	1/8"	0.93	73	<2.5
C	SCP021-T1600-FAS4Q	1461134	1600	1/4"	0.4-2.1	0.6-2.1	245	6.5	6	1/8"	0.93	73	<2.5
C	SCP043-T1100-FAS4Q	1461144	1100	1/4"	0.4-4.3	0.9-4.3	245	6.5	6	1/8"	0.93	73	<2.5
C	SCP047-T550-FAS4Q	1461154	550	1/4"	0.4-4.7	0.9-4.7	245	6.5	6	1/8"	0.93	73	<2.5
D	2D89-PX-2200-FAS	1461284	2200	1/4"	0.9-3.6	0.9-3.5	244	8	10	1/4"	1.3	72	<2.5
D	2D89-PX-1500-FAS	1461294	1500	1/4"	0.9-4.5	0.9-3.5	257	8	10	1/4"	1.3	72	<2.5
D	2D89-PX-850-FAS	1461304	850	1/4"	1.5-6.8	1.5-6.6	257	8	10	1/4"	1.3	72	<2.5
D	2D89-PX-540-FAS	1461314	540	1/4"	1.5-10.7	2.0-10.7	257	8	10	1/4"	1.3	72	<2.5
D	2D89-PX-340-FAS	1461324	340	1/4"	3.6-16.6	3.6-16.6	269	8	10	1/4"	1.3	72	<2.5
E	2D89-LX-2200-FAS	1460324	2200	1/4"	0.9-3.6	0.9-3.5	277	8	10	1/4"	1.0	73	<2.5
E	2D89-LX-1500-FAS	1460334	1500	1/4"	0.8-4.8	0.8-2.7	295	8	10	1/4"	1.0	73	<2.5
E	2D89-LX-1050-FAS	1460344	1050	1/4"	1.8-6.5	1.8-5.3	295	8	10	1/4"	1.0	73	<2.5
E	2D89-LX-540-FAS	1460354	540	1/4"	1.4-9.1	1.4-5.3	295	8	10	1/4"	1.0	73	<2.5
E	2D89-LX-340-FAS	1460364	340	1/4"	3.6-14.7	3.6-14.7	307	8	10	1/4"	1.0	73	<2.5

## POWER CABLE AND PLUG

PICTURE REF	DESCRIPTION	PART NUMBER	LENGTH
			mm
F	Mains Power Cable (UK)	396843	2000
F	Mains Power Cable (Europe)	396853	2000

# Screwdrivers – Non Shut Off – Push and Lever Start

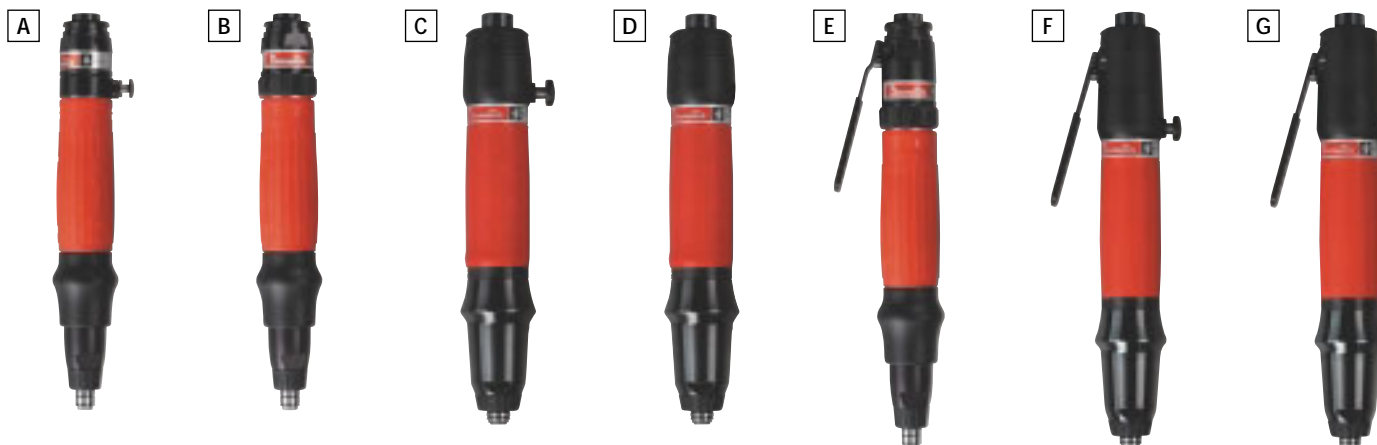

## PUSH START

PICTURE REF	TOOL TYPE	PART NUMBER	FREE SPEED	OUTPUT <sup>(1)</sup>	TORQUE RANGE	FITTED SPRING	LENGTH	WEIGHT	AIR FLOW	AIR HOSE BORE	AIR INLET <sup>(2)</sup>	SOUND LEVEL	VIBRATION
			r/min	hex	Nm	Nm	mm	kg	l/s	mm	BSP	dB(A)	ms <sup>-2</sup>
A	SC024-AB2300-R4Q	1461894	2300	1/4"	0.5-2.4	0.5-1.8	250	0.61	6.5	6	1/8"	75	2-5
A	SC022-AB1600-R4Q	1461904	1600	1/4"	0.5-2.2	0.8-2.2	250	0.61	6.5	6	1/8"	75	3-9
A	SC044-AB1100-R4Q	1461914	1100	1/4"	0.4-4.4	1.3-4.4	250	0.61	6.5	6	1/8"	75	9-35
A	SC044-AB550-R4Q	1461924	550	1/4"	0.4-4.4	1.0-4.4	250	0.61	6.5	6	1/8"	75	10-29
B	SC024-A2300-R4Q	1456614	2300	1/4"	0.5-2.4	0.5-1.8	250	0.61	6.5	6	1/8"	73	2-5
B	SC022-A1600-R4Q	1456624	1600	1/4"	0.5-2.2	0.8-2.2	250	0.61	6.5	6	1/8"	73	3-9
B	SC044-A1100-R4Q	1456634	1100	1/4"	0.4-4.4	1.3-4.4	250	0.61	6.5	6	1/8"	73	9-35
B	SC044-A550-R4Q	1456644	550	1/4"	0.4-4.4	1.0-4.4	250	0.61	6.5	6	1/8"	73	10-29
C	SD023-AB3500-R4Q	1462954	3500	1/4"	1.0-2.3	1.0-2.3	227	0.73	8.7	10	1/4"	73	TBA
C	SD035-AB2200-R4Q	1462944	2200	1/4"	1.0-3.5	1.0-3.5	227	0.73	8.7	10	1/4"	73	TBA
C	SD055-AB1470-R4Q	1462934	1470	1/4"	2.0-5.5	2.0-5.5	253	0.89	8.7	10	1/4"	73	16.1
C	SD075-AB1100-R4Q	1462924	1100	1/4"	2.5-7.5	2.5-7.5	253	0.89	8.7	10	1/4"	73	14.9
C	SD100-AB820-R4Q	1462914	820	1/4"	3.5-10.0	3.5-10.0	253	0.89	8.7	10	1/4"	73	TBA
C	SD140-AB510-R4Q	1462904	510	1/4"	3.5-10.0	3.5-10.0	253	0.89	8.7	10	1/4"	73	14.7
D	SD023-AR3500-R4Q	1462894	3500	1/4"	1.0-2.3	1.0-2.3	227	0.73	8.7	10	1/4"	73	TBA
D	SD035-AR2200-R4Q	1462884	2200	1/4"	1.0-3.5	1.0-3.5	227	0.73	8.7	10	1/4"	73	TBA
D	SD055-AR1470-R4Q	1462874	1470	1/4"	2.0-5.5	2.0-5.5	253	0.89	8.7	10	1/4"	73	16.1
D	SD075-AR1100-R4Q	1462864	1100	1/4"	2.5-7.5	2.5-7.5	253	0.89	8.7	10	1/4"	73	14.9
D	SD100-AR820-R4Q	1462854	820	1/4"	3.5-10.0	3.5-10.0	253	0.89	8.7	10	1/4"	73	TBA
D	SD140-AR510-R4Q	1462844	510	1/4"	3.5-10.0	3.5-10.0	253	0.89	8.7	10	1/4"	73	14.7

## LEVER START

PICTURE REF	TOOL TYPE	PART NUMBER	FREE SPEED	OUTPUT <sup>(1)</sup>	TORQUE RANGE	FITTED SPRING	LENGTH	WEIGHT	AIR FLOW	AIR HOSE BORE	AIR INLET <sup>(2)</sup>	SOUND LEVEL	VIBRATION
			r/min	hex	Nm	Nm	mm	kg	l/s	mm	BSP	dB(A)	ms <sup>-2</sup>
E	SC024-L2300-R4Q	1456694	2300	1/4"	0.5-2.4	0.5-1.8	250	0.61	6.5	6	1/8"	75	2-5
E	SC022-L1600-R4Q	1456704	1600	1/4"	0.5-2.2	0.8-2.2	250	0.61	6.5	6	1/8"	75	3-9
E	SC044-L1100-R4Q	1456714	1100	1/4"	0.4-4.4	1.3-4.4	250	0.61	6.5	6	1/8"	75	9-35
E	SC044-L550-R4Q	1456724	550	1/4"	0.4-4.4	1.0-4.4	250	0.61	6.5	6	1/8"	75	10-29
F	SD023-LB3500-R4Q	1463214	3500	1/4"	1.0-2.3	1.0-2.3	252	0.76	8.7	10	1/4"	73	TBA
F	SD035-LB2200-R4Q	1463204	2200	1/4"	1.0-3.5	1.0-3.5	252	0.76	8.7	10	1/4"	73	TBA
F	SD055-LB1470-R4Q	1463194	1470	1/4"	2.0-5.5	2.0-5.5	278	0.92	8.7	10	1/4"	73	16.1
F	SD075-LB1100-R4Q	1463184	1100	1/4"	2.5-7.5	2.5-7.5	278	0.92	8.7	10	1/4"	73	14.9
F	SD100-LB820-R4Q	1463174	820	1/4"	3.5-10.0	3.5-10.0	278	0.92	8.7	10	1/4"	73	TBA
F	SD140-LB510-R4Q	1463164	510	1/4"	3.5-10.0	3.5-10.0	278	0.92	8.7	10	1/4"	73	14.7
G	SD023-LR3500-R4Q	1463154	3500	1/4"	1.0-2.3	1.0-2.3	252	0.76	8.7	10	1/4"	73	TBA
G	SD035-LR2200-R4Q	1463144	2200	1/4"	1.0-3.5	1.0-3.5	252	0.76	8.7	10	1/4"	73	TBA
G	SD055-LR1470-R4Q	1463134	1470	1/4"	2.0-5.5	2.0-5.5	278	0.92	8.7	10	1/4"	73	16.1
G	SD075-LR1100-R4Q	1463124	1100	1/4"	2.5-7.5	2.5-7.5	278	0.92	8.7	10	1/4"	73	14.9
G	SD100-LR820-R4Q	1463114	820	1/4"	3.5-10.0	3.5-10.0	278	0.92	8.7	10	1/4"	73	TBA
G	SD140-LR510-R4Q	1463104	510	1/4"	3.5-10.0	3.5-10.0	278	0.92	8.7	10	1/4"	73	14.7

<sup>(1)</sup> Types A, B and F, 5/16" hex bit optional

<sup>(2)</sup> NPT optional

A side handle should be fitted for torques over 4Nm (SD tools are supplied with a side handle as standard)

# Screwdrivers – Non Shut Off – Pistol Grip



## PUSH AND TRIGGER START

PICTURE REF	TOOL TYPE	PART NUMBER	FREE SPEED	OUTPUT <sup>(1)</sup>	TORQUE RANGE	FITTED SPRING	LENGTH	WEIGHT	AIR FLOW	AIR HOSE BORE	AIR INLET <sup>(2)</sup>	SOUND LEVEL	VIBRATION
			r/min	hex	Nm	Nm	mm	kg	l/s	mm	BSP	dB(A)	ms <sup>-2</sup>
A	SBP024-T2300-R4Q	1462184	2300	1/4"	0.5-2.4	0.5-2.4	182	0.82	6.5	6	1/8"	73	0.9-2.5
A	SBP022-T1600-R4Q	1462194	1600	1/4"	0.5-2.2	0.5-2.2	182	0.82	6.5	6	1/8"	73	1.8-3.2
A	SBP044-T1100-R4Q	1462204	1100	1/4"	0.4-4.4	1.8-4.4	182	0.82	6.5	6	1/8"	73	2.3-3.9
A	SBP044-T550-R4Q	1462214	550	1/4"	0.4-4.4	1.8-4.4	182	0.82	6.5	6	1/8"	73	1.7-4.7

## TRIGGER START

PICTURE REF	TOOL TYPE	PART NUMBER	FREE SPEED	OUTPUT <sup>(1)</sup>	TORQUE RANGE	FITTED SPRING	LENGTH	WEIGHT	AIR FLOW	AIR HOSE BORE	AIR INLET <sup>(2)</sup>	SOUND LEVEL	VIBRATION
			r/min	hex	Nm	Nm	mm	kg	l/s	mm	BSP	dB(A)	ms <sup>-2</sup>
B	SCP024-T2300-R4Q	1456774	2300	1/4"	0.5-2.4	0.5-1.8	228	0.86	6.5	6	1/8"	73	0.9-2.5
B	SCP022-T1600-R4Q	1456784	1600	1/4"	0.5-2.2	0.8-2.2	228	0.86	6.5	6	1/8"	73	1.8-3.2
B	SCP044-T1100-R4Q	1456794	1100	1/4"	0.4-4.4	1.3-4.4	228	0.86	6.5	6	1/8"	73	2.3-3.9
B	SCP044-T550-R4Q	1456804	550	1/4"	0.4-4.4	1.0-4.4	228	0.86	6.5	6	1/8"	73	1.7-4.7
C	SCPT024-A2300-R4Q	1458994	2300	1/4"	0.5-2.4	0.5-1.8	230	0.86	6.5	6	1/8"	73	0.9-2.5
C	SCPT022-A1600-R4Q	1458954	1600	1/4"	0.5-2.2	0.8-2.2	230	0.86	6.5	6	1/8"	73	1.8-3.2
C	SCPT044-A1100-R4Q	1458914	1100	1/4"	0.4-4.4	1.3-4.4	230	0.86	6.5	6	1/8"	73	2.3-3.9
C	SCPT044-A550-R4Q	1458874	550	1/4"	0.4-4.4	1.0-4.4	230	0.86	6.5	6	1/8"	73	1.7-4.7
D	2D8-PX-2200	1455574	2200	1/4"	0.6-3.6	0.6-1.5	198	1.1	8	10	1/4"	72	1.4-2.6
D	2D8-PX-1500	1455554	1500	1/4"	1.5-6.8	1.5-4.5	211	1.1	8	10	1/4"	72	3.1-3.8
D	2D8-PX-850	1455534	850	1/4"	1.5-6.8	1.5-4.5	211	1.1	8	10	1/4"	72	2.5-3.4
D	2D8-PX-540	1455514	540	1/4"	1.5-10.0	3.6-6.8	211	1.1	8	10	1/4"	72	3.7-4.7
D	2D8-PX-340	1455494	340	1/4"	1.5-10.0	3.6-6.8	211	1.1	8	10	1/4"	72	<2.5
E	2F8-PX-2000	1236884	2000	1/4"	0.6-4.5	1.5-4.5	196	1.3	9.4	10	1/4"	82	<2.5
E	2F8-PX-1100	1236624	1100	1/4"	1.5-6.3	1.5-4.5	216	1.5	9.4	10	1/4"	82	<2.5
E	2F8-PX-650	1235654	650	1/4"	1.5-8.0	3.6-8.0	216	1.5	9.4	10	1/4"	82	<2.5
E	2F8-PX-450	1235814	450	1/4"	3.6-10.0	3.6-8.0	216	1.5	9.4	10	1/4"	82	2.1-2.8
E	2F8-PX-750	1236384	750	1/4"	9.0-15.0	9.0-15.0	256	1.8	9.4	10	1/4"	82	5.3-6.2
E	2F8-PX-500	1236044	500	1/4"	10.0-15.0	10.0-15.0	256	1.8	9.4	10	1/4"	82	6.0-9.2

<sup>(1)</sup> Types B, C, D and E, 5/16" hex bit holder optional

<sup>(2)</sup> NPT optional

<sup>(3)</sup> Types B and C are available with a steel nose

A side handle should be fitted for torques over 10Nm

# Screwdrivers – Direct Drive and Auto Reverse

A



B



## TRIGGER START

PICTURE REF	TOOL TYPE	PART NUMBER	FREE SPEED	OUTPUT <sup>(1)</sup>	TORQUE RANGE	LENGTH	WEIGHT	AIR FLOW	AIR HOSE BORE	AIR INLET <sup>(2)</sup>	SOUND LEVEL	VIBRATION
			r/min	hex	Nm	mm	kg	l/s	mm	BSP	dB(A)	ms <sup>-2</sup>
A	2D2-PX-2300	1391264	2300	1/4"	0.3-3.0	207	1.0	8.3	10	1/4"	72	<2.5
A	2D2-PX-1450	1391004	1450	1/4"	0.5-5.0	207	1.0	8.3	10	1/4"	72	<2.5
A	2D2-PX-900	1390874	900	1/4"	0.9-9.0	207	1.0	8.3	10	1/4"	72	<2.5
A	2D2-PX-500	1390614	500	1/4"	1.4-14.0	207	1.0	8.3	10	1/4"	72	<2.5
B	2F2-PX-750	1239054	750	1/4"	1.2-12.0	215	1.5	9.4	10	1/4"	82	<2.5
B	2F2-PX-500	1239214	500	1/4"	1.8-18.0	215	1.5	9.4	10	1/4"	82	<2.5

<sup>(1)</sup> All types, 5/16" hex bit holder optional

<sup>(2)</sup> NPT optional

A



B



## AUTOMATIC REVERSE – FOR USE WITH RIVNUTS

PICTURE REF	TOOL TYPE	PART NUMBER	FREE SPEED	OUTPUT	TORQUE RANGE	LENGTH	WEIGHT	AIR FLOW	AIR HOSE BORE	AIR INLET <sup>(1)</sup>	SOUND LEVEL	VIBRATION
			r/min	hex	Nm	mm	kg	l/s	mm	BSP	dB(A)	ms <sup>-2</sup>
A	2D189-LX-1100	1359784	1100	See kits	3.5	360	1.3	7.5	10	1/4"	73	<2.5
A	2D189-LX-550	1359604	550	below	7	360	1.3	7.5	10	1/4"	73	<2.5
B	2F189-PX-900	1240584	900	See kits	1.8-8.9	303	1.6	9.4	10	1/4"	82	<2.5
B	2F189-PX-600	1240744	600	below	1.6-14.0	303	1.6	9.4	10	1/4"	82	<2.5
B	2F189-PX-400	1240904	400		1.6-15.6	303	1.6	9.4	10	1/4"	82	<2.5

<sup>(1)</sup> NPT optional

A side handle should be fitted for torques over 10Nm

## NOSE KITS

OUTPUT	PART NUMBER
M3x0.5	76552
M4x0.7	76562
M5x0.8	76572
M6x1.0	76582
M8x1.25	76592

## HOW TO ORDER

1. Order tool from table above
2. Order nose kit from table

# Impulse – Shut Off and Non Shut Off



## NON SHUT OFF

PICTURE REF	TOOL TYPE	PART NUMBER	FREE SPEED	OUTPUT	TORQUE RANGE	LENGTH	WEIGHT	AIR FLOW	AIR HOSE BORE	AIR INLET <sup>(1)</sup>	SOUND LEVEL <sup>(2)</sup>	VIBRATION
				r/min								
A	PT008-L10500-I4Q	1461384	10500	1/4" hex	4-8	238	0.95	5	8	1/4"	72	<2.5
A	PT013-L10500-I4Q	1461394	10500	1/4" hex	8-13	263	1.0	5	8	1/4"	72	<2.5
B	PT030-L9000-I10S	1461404	9000	3/8" sq	15-30	246	1.2	5	8	1/4"	73	<2.5
C	PT009-T7800-I4Q	1461414	7800	1/4" hex	5-9	184	0.95	6	8	1/4"	76	<2.5
C	PT016-T7800-I4Q	1461784	7800	1/4" hex	9-16	208	1.05	6	8	1/4"	76	<2.5
D	PT035-T9000-I10S	1461424	9000	3/8" sq	20-35	175	0.98	6	8	1/4"	77	<2.5
E	PT070-T7500-I13S	1461434	7500	1/2" sq	42-70	179	2.0	7	8	1/4"	79	<2.5
F	PT115-T6000-I13S	1461444	6000	1/2" sq	75-115	185	2.7	9	10	3/8"	78	2.5
F	PT200-T5500-I13S	1461454	5500	1/2" sq	120-200	181	3.3	11	10	3/8"	81	2.7
F	PT250-T4000-I19S	1461464	4000	3/4" sq	160-250	232	4.3	12	10	3/8"	80	4.5

## SHUT OFF

PICTURE REF	TOOL TYPE	PART NUMBER	FREE SPEED	OUTPUT	TORQUE RANGE	LENGTH	WEIGHT	AIR FLOW	AIR HOSE BORE	AIR INLET <sup>(1)</sup>	SOUND LEVEL <sup>(2)</sup>	VIBRATION
				r/min								
G	PT010-L5000-S4Q	1462254	5000	1/4" hex	5-10	212	0.9	6	8	1/4"	74	<2.5
G	PT014-L6000-S4Q	1462264	6000	1/4" hex	8-14	212	0.9	6	8	1/4"	74	<2.5
H	PT010-T5500-S4Q	1462274	5500	1/4" hex	5-10	166	0.95	6	8	1/4"	74	<2.5
H	PT014-T6000-S4Q	1462284	6000	1/4" hex	8-14	166	1	6	8	1/4"	74	<2.5
I	PT040-T6000-S10S	1462294	6000	3/8" sq	22-40	177	1.4	8	8	1/4"	77	<2.5
J	PT070-T4000-S13S	1462304	4000	1/2" sq	32-70	192	1.8	10	10	1/4"	81	<2.5
K	PT125-T3500-S13S	1462314	3500	1/2" sq	62-125	201	2.4	12	10	1/4"	81	3.3

<sup>(1)</sup> NPT optional

<sup>(2)</sup> Sound level measured to test code PN8NCT1.2

# Angle Head – Shut Off

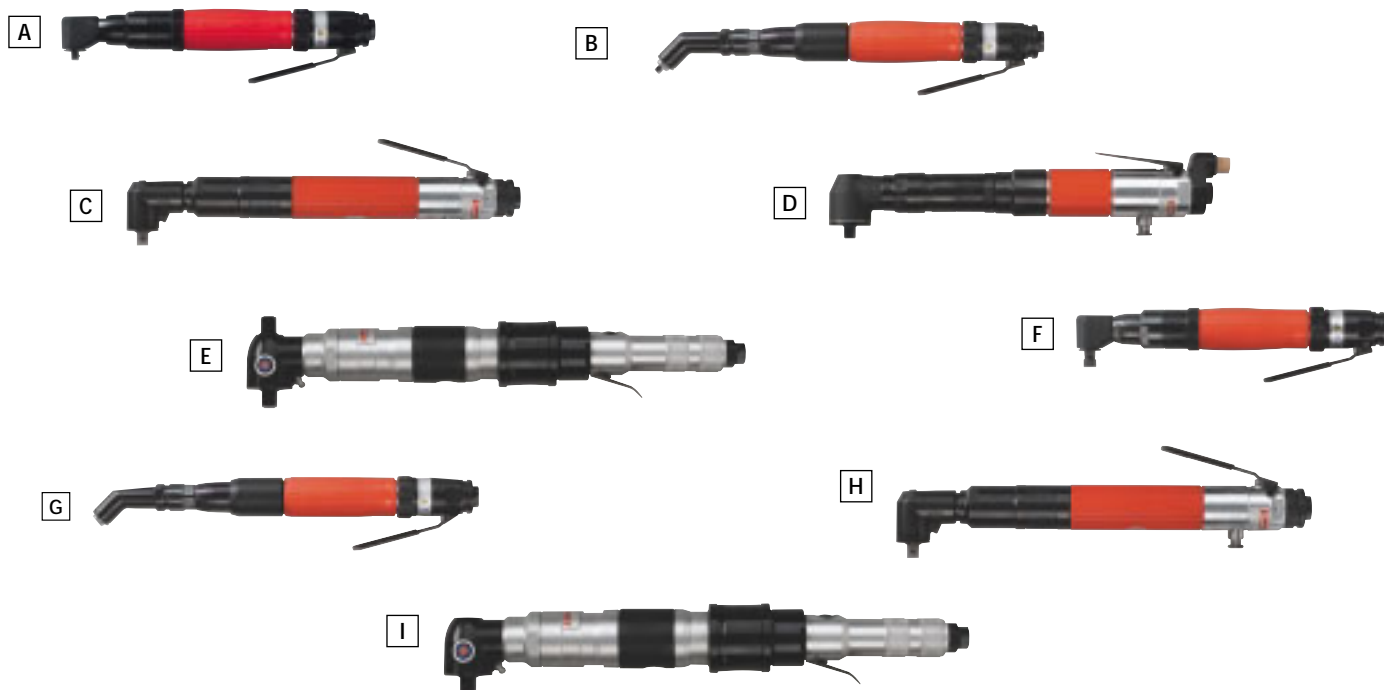

## TWO WAY

PICTURE REF	TOOL TYPE	PART NUMBER	FREE SPEED	OUTPUT	TORQUE RANGE	FITTED SPRING	LENGTH	WEIGHT	AIR FLOW	AIR HOSE BORE	AIR INLET <sup>(1)</sup>	SOUND LEVEL	VIBRATION
			r/min	hex	Nm	Nm	mm	kg	l/s	mm	BSP	dB(A)	ms <sup>-2</sup>
A	SC021-L2000-S90A4S	1459154	2000	1/4" sq	0.4-2.1	0.4-0.9	275	0.84	6.5	6	1/8"	73	<2.5
A	SC021-L1400-S90A4S	1459144	1400	1/4" sq	0.4-2.1	0.6-2.1	275	0.84	6.5	6	1/8"	73	<2.5
A	SC043-L950-S90A4S	1459134	950	1/4" sq	0.4-4.3	0.9-4.3	275	0.84	6.5	6	1/8"	73	<2.5
A	SC047-L500-S90A4S	1459124	500	1/4" sq	0.4-4.7	0.9-4.7	275	0.84	6.5	6	1/8"	73	<2.5
B	SC021-L2200-S45A4S	1459574	2200	1/4" sq	0.4-2.1	0.4-0.9	339	0.85	6.5	6	1/8"	73	<2.5
B	SC021-L1500-S45A4S	1459584	1500	1/4" sq	0.4-2.1	0.6-2.1	339	0.85	6.5	6	1/8"	73	<2.5
B	SC043-L1050-S45A4S	1459594	1050	1/4" sq	0.4-4.3	0.9-4.3	339	0.85	6.5	6	1/8"	73	<2.5
B	SC047-L520-S45A4S	1459604	520	1/4" sq	0.4-4.7	0.9-4.7	339	0.85	6.5	6	1/8"	73	<2.5
C	2D489-LX-1100	1378574	1100	3/8" sq	1.9-5.8	1.9-5.8	324	1.2	8.2	10	1/4"	73	<2.5
C	2D489-LX-650	1378654	650	3/8" sq	2.4-8.8	2.4-8.8	345	1.3	8.2	10	1/4"	73	<2.5
C	2D489-LX-400	1378734	400	3/8" sq	3.5-14.1	3.5-14.1	376	1.7	8.2	10	1/4"	73	<2.5
C	2D489-LX-260	1378814	260	3/8" sq	7.3-21.0	7.3-21.0	376	1.7	8.2	10	1/4"	73	<2.5
C	2D489-LX-160	1389184	160	3/8" sq	7.3-28.0	7.3-28.0	376	1.7	8.2	10	1/4"	73	<2.5
D	2F489-LX-470	1462324	470	3/8" sq	7.0-17.0	7.0-17.0	350	2.1	9.4	10	1/4"	78	<2.5
D	2F489-LX-300	1462334	300	3/8" sq	9.0-25.0	9.0-25.0	362	2.5	9.4	10	1/4"	78	<2.5
E	4H489-N-750	1301984	750	3/8" sq	12.2-36.0	12.2-36.0	435	3.1	16.5	12	3/8"	84	<2.5
E	4H489-N-480	1301804	480	1/2" sq	25.5-47.0	25.5-47.0	459	3.1	16.5	12	3/8"	84	<2.5
F	SC021-L2000-S90A4H	1459074	2000	1/4" hex	0.4-2.1	0.4-0.9	275	0.84	6.5	6	1/8"	73	<2.5
F	SC021-L1400-S90A4H	1459064	1400	1/4" hex	0.4-2.1	0.6-2.1	275	0.84	6.5	6	1/8"	73	<2.5
F	SC043-L950-S90A4H	1459054	950	1/4" hex	0.4-4.3	0.9-4.3	275	0.84	6.5	6	1/8"	73	<2.5
F	SC047-L500-S90A4H	1459044	500	1/4" hex	0.4-4.7	0.9-4.7	275	0.84	6.5	6	1/8"	73	<2.5
G	SC021-L2200-S45A4H	1459484	2200	1/4" hex	0.4-2.1	0.4-0.9	339	0.85	6.5	6	1/8"	73	<2.5
G	SC021-L1500-S45A4H	1459494	1500	1/4" hex	0.4-2.1	0.6-2.1	339	0.85	6.5	6	1/8"	73	<2.5
G	SC043-L1050-S45A4H	1459504	1050	1/4" hex	0.4-4.3	0.9-4.3	339	0.85	6.5	6	1/8"	73	<2.5
G	SC047-L520-S45A4H	1459514	520	1/4" hex	0.4-4.7	0.9-4.7	339	0.85	6.5	6	1/8"	73	<2.5

## ONE WAY

PICTURE REF	TOOL TYPE	PART NUMBER	FREE SPEED	OUTPUT	TORQUE RANGE	FITTED SPRING	LENGTH	WEIGHT	AIR FLOW	AIR HOSE BORE	AIR INLET <sup>(1)</sup>	SOUND LEVEL	VIBRATION
			r/min	hex	Nm	Nm	mm	kg	l/s	mm	BSP	dB(A)	ms <sup>-2</sup>
H	D489-LX-300	1378494	300	3/8"	7.9-22.0	7.9-22.0	366	1.7	8.8	10	1/4"	77	<2.5
I	H489-N-750	1301724	750	3/8"	12.2-36.0	12.2-36.0	435	2.3	16.5	12	3/8"	84	<2.5
I	H489-N-480	1301644	480	1/2"	25.5-47.0	25.5-47.0	459	3.1	16.5	12	3/8"	84	<2.5
I	H489-N-200	1301564	200	1/2"	30.1-103.0	30.1-103.0	459	3.1	16.5	12	3/8"	84	<2.5

<sup>(1)</sup> NPT optional



# Angle Head – Non Shut Off and Direct Drive

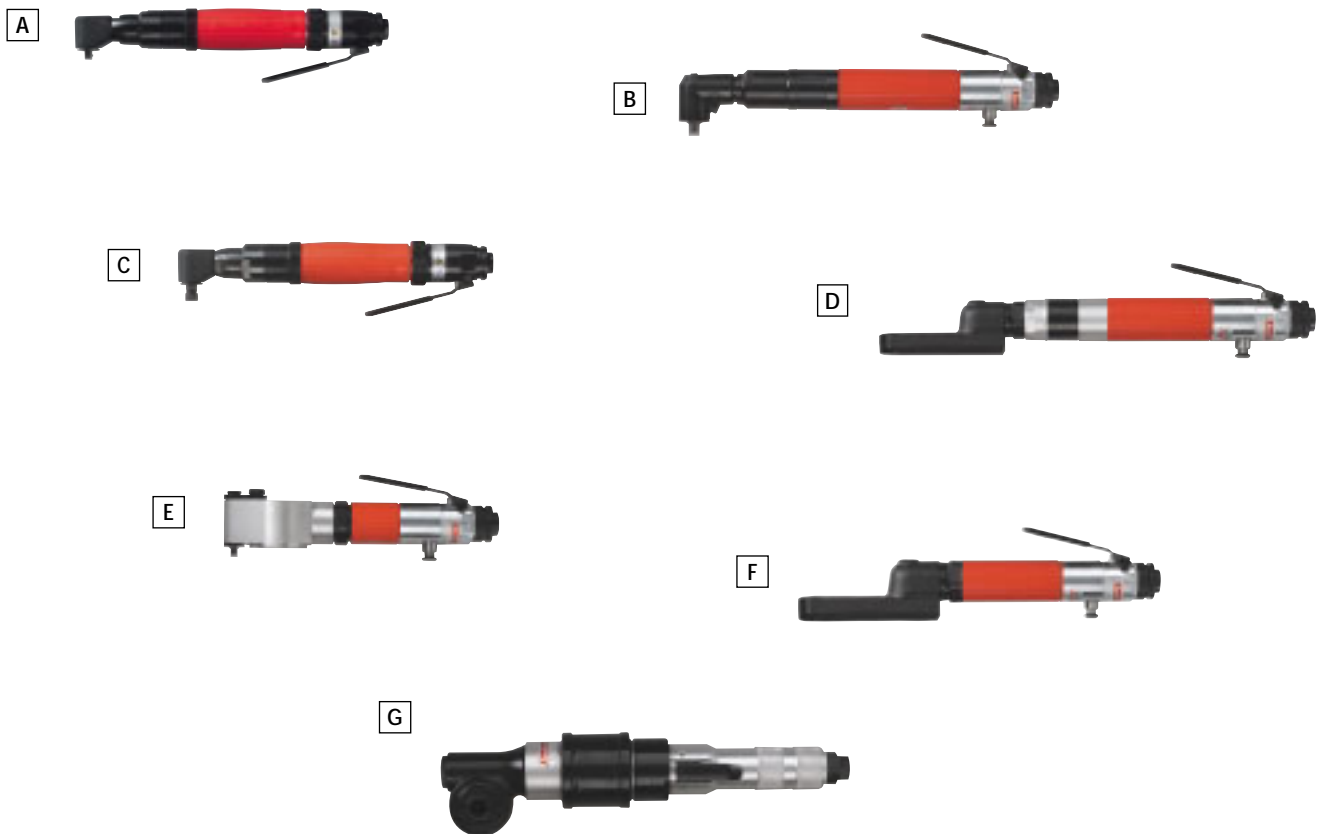

## NON SHUT OFF

PICTURE REF	TOOL TYPE	PART NUMBER	FREE SPEED	OUTPUT	TORQUE RANGE	FITTED SPRING	LENGTH	WEIGHT	AIR FLOW	AIR HOSE BORE	AIR INLET <sup>(1)</sup>	SOUND LEVEL	VIBRATION
			r/min	hex	Nm	Nm							
A	SC024-L2000-R90A4S	1459194	2000	1/4" sq	0.5-2.4	0.5-1.8	275	0.84	6.5	6	1/8"	73	3.7-8.2
A	SC022-L1400-R90A4S	1459184	1400	1/4" sq	0.5-2.2	0.8-2.2	275	0.84	6.5	6	1/8"	73	2.7-7.2
A	SC044-L950-R90A4S	1459174	950	1/4" sq	0.4-4.4	1.3-4.4	275	0.84	6.5	6	1/8"	73	3.2-9.9
A	SC044-L500-R90A4S	1459164	500	1/4" sq	0.4-4.4	1.0-4.4	275	0.84	6.5	6	1/8"	73	4.5-5.2
B	2D48-LX-400	1387984	400	3/8" sq	7.7-14.4	7.7-14.4	334	1.4	8.5	10	1/4"	73	1.3-3.0
B	2D48-LX-260	1388034	260	3/8" sq	7.7-14.4	7.7-14.4	334	1.4	8.5	10	1/4"	73	1.7-3.1
C	SC024-L2000-R90A4H	1459114	2000	1/4" hex	0.5-2.4	0.5-1.8	275	0.84	6.5	6	1/8"	73	3.7-8.2
C	SC022-L1400-R90A4H	1459104	1400	1/4" hex	0.5-2.2	0.8-2.2	275	0.84	6.5	6	1/8"	73	2.7-7.2
C	SC044-L950-R90A4H	1459094	950	1/4" hex	0.4-4.4	1.3-4.4	275	0.84	6.5	6	1/8"	73	3.2-9.9
C	SC044-L500-R90A4H	1459084	500	1/4" hex	0.4-4.4	1.0-4.4	275	0.84	6.5	6	1/8"	73	4.5-5.2
D	2D4872-LX-550	1388614	550	0.445" hex	3.6-6.8	3.6-6.8	382	1.1	8.5	10	1/4"	73	4.1-5.2

## DIRECT DRIVE

PICTURE REF	TOOL TYPE	PART NUMBER	FREE SPEED	OUTPUT	TORQUE RANGE	LENGTH	WEIGHT	AIR FLOW	AIR HOSE BORE	AIR INLET <sup>(1)</sup>	SOUND LEVEL	VIBRATION
			r/min	hex	Nm							
E	2D4201-LX-500	1344854	500	1/4" sq	1.5-15.4	238	1.1	8	10	1/4"	77	<2.5
F	2D472-LX-550	1388534	550	0.445" hex	1.2-12.6	326	1.0	8.5	10	1/4"	73	<2.5
G	H410-N-500	1302374	500	0.525" hex	3-30	319	1.7	17.9	12	3/8"	82	<2.5
G	H410-N-350	1302454	350	0.525" hex	4.5-45	319	1.7	17.9	12	3/8"	82	<2.5
G	H410-N-150	1302534	150	0.525" hex	8-80	358	2.0	17.9	12	3/8"	82	<2.5
G	H410-N-90	1302614	90	0.525" hex	10-105	358	2.0	13.2	12	3/8"	82	<2.5
G	H410-N-60	1302794	60	0.525" hex	10-105	358	2.0	13.2	12	3/8"	82	<2.5

Pressure on H410-N-90 and 60 must be adjusted so that tool torque output does not exceed 105Nm

<sup>(1)</sup> NPT optional

# Screwdrivers – Electric

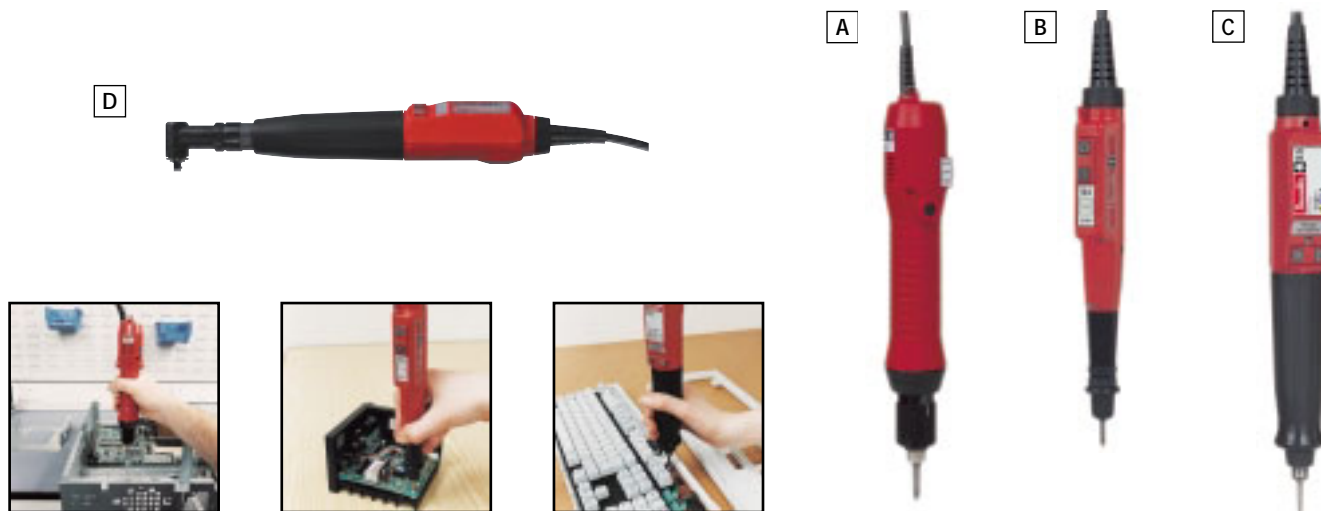

- EMC Approved
- ETL Listed (S4 and S5)
- UL Listed (SME)

## PUSH START

PICTURE REF	TOOL TYPE	PART NUMBER	FREE SPEED	OUTPUT	TORQUE RANGE	FITTED SPRING	LENGTH	WEIGHT	VOLTAGE	CONTROLLER	SOUND LEVEL	VIBRATION
			r/min	hex	Nm	Nm	mm	kg	V AC		dB(A)	ms <sup>-2</sup>
A	SME021-A1000-54U	1458554	1000	1/4"	0.5-2.1	-	264	1.05	230	-	61	<2.5
A	SME021-A700-54U	1458604	700	1/4"	1.0-2.9	-	269	1.05	230	-	60	<2.5
A	SME021-A500-54U	1458624	500	1/4"	1.5-3.9	-	269	1.05	230	-	60	<2.5
B	S4X2A-1000	1225774	1000	3mm	0.09-0.61	0.15-0.43	210	0.28	36	ESP6	54	<2.5
B	S4X2A-800	1225854	800	3mm	0.09-0.72	0.15-0.43	210	0.28	36	ESP6	54	<2.5
B	S4X2A-500	1225934	500	3mm	0.08-0.72	0.15-0.43	210	0.28	36	ESP6	54	<2.5
B	S4X2A-800	1223574	800	1/4"	0.09-0.72	0.15-0.43	210	0.28	36	ESP6	54	<2.5
B	S4X2A-500	1223654	500	1/4"	0.08-0.72	0.15-4.3	210	0.28	36	ESP6	54	<2.5
C	S5V2A-1100	1343124	1100	1/4"	0.4-0.8	0.4-0.8	250	0.8	36	ESP6	59	<2.5
C	S5V2A-650	1343384	650	1/4"	0.63-1.5	0.63-1.5	267	0.8	36	ESP6	59	<2.5
C	S5V2A-400	1343544	400	1/4"	0.7-2.3	0.7-2.3	267	0.8	36	ESP6	59	<2.5

## BUTTON START

PICTURE REF	TOOL TYPE	PART NUMBER	FREE SPEED	OUTPUT	TORQUE RANGE	FITTED SPRING	LENGTH	WEIGHT	VOLTAGE	CONTROLLER	SOUND LEVEL	VIBRATION
			r/min	hex	Nm	Nm	mm	kg	V AC		dB(A)	ms <sup>-2</sup>
B	S4X2M-800	1421954	800	1/4"	0.09-0.72	0.15-0.43	210	0.28	36	ESP6	54	<2.5
C	S5V2M-650	1344194	650	1/4"	0.45-1.4	0.7-1.4	250	0.8	36	ESP6	59	<2.5
C	S5V2M-400	1344354	400	1/4"	0.36-1.9	0.8-1.9	267	0.9	36	ESP6	59	<2.5

## PUSH START – CURRENT CONTROL

PICTURE REF	TOOL TYPE	PART NUMBER	FREE SPEED	OUTPUT	TORQUE RANGE	LENGTH	WEIGHT	VOLTAGE	CONTROLLER	SOUND LEVEL	VIBRATION
			r/min	hex	Nm	mm	kg	V AC		dB(A)	ms <sup>-2</sup>
B	S4Y2A-800	1226244	800	3mm	0.09-0.73	189	0.26	36	ESP6	54	<2.5
C	S5Z2A-400	1376794	400	1/4"	0.68-2.00	267	0.7	36	ESP6	59	<2.5

## BUTTON START – ANGLE HEAD

PICTURE REF	TOOL TYPE	PART NUMBER	FREE SPEED	OUTPUT	TORQUE RANGE	FITTED SPRING	LENGTH	WEIGHT	VOLTAGE	CONTROLLER	SOUND LEVEL	VIBRATION
			r/min	hex	Nm	Nm	mm	kg	V AC		dB(A)	ms <sup>-2</sup>
D	S5V2M-650-90H	1460474	650	1/4" hex	0.45-1.4	0.7-1.4	312	0.9	36	ESP6	59	<2.5
D	S5V2M-400-90H	1460434	400	1/4" hex	0.36-1.9	0.8-1.9	329	1.0	36	ESP6	59	<2.5
D	S5V2M-650-90S	1460464	650	1/4" sq	0.45-1.4	0.7-1.4	312	0.9	36	ESP6	59	<2.5
D	S5V2M-400-90S	1460424	400	1/4" sq	0.36-1.9	0.8-1.9	329	1.0	36	ESP6	59	<2.5

Type A – recommended duty cycle, maximum 12 screws per minute

Types B, C and D – recommended duty cycle, maximum 24 screws per minute

# Screwdrivers – Low Voltage Electric Controllers

## ESP6 Low Voltage Electric Screwdriver Programmer

Programmable modular controller for S4 and S5 low voltage screwdrivers

There are 5 control options:

- 1 Shut off
- 2 Shut off with speed control
- 3 Shut off with speed control and auto reverse option
- 4 Current control with speed control and auto reverse option
- 5 Shut off or current control with speed control and auto reverse options or fastening assurance system

The speed control feature allows the speed during the cycle to be controlled in 3 phases, 4 with the auto reverse facility.

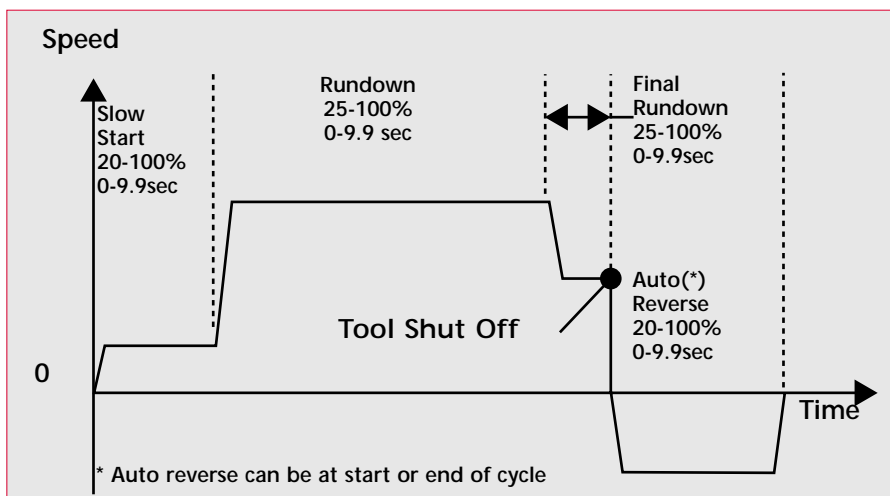

### Features

- Push start options of automatic or combination automatic and button
- Automatic tool type recognition
- Left hand or right hand rotation
- 4 selectable parameter groups on options 3, 4 and 5
- Cycle complete indicator
- LCD display and 3 button keypad for simple programming
- 11 languages available in program
- Remote 24V DC I/O interface on options 2, 3, 4 and 5 (external 24v DC supply required)
- Switchable supply voltage AC230, 50Hz or AC120, 60Hz
- EMC and ETL listed

Control Options	Auto Start options	Automatic tool recognition	Left/Right hand rotation	Tool running indicator	Slow start speed control	RunDown Speed control	Final speed control	Reverse speed control	Auto reverse	Current control	4 parameter groups	FAS capability	Remote interface port
<b>Option 1</b> Controller Part no. 108232	✓	✓	✓	✓									
<b>Option 2</b> Controller Part no. 108232 Control card Part no. 108242	✓	✓	✓	✓	✓	✓	✓	✓					✓
<b>Option 3</b> Controller Part no. 108232 Control card Part no. 108252	✓	✓	✓	✓	✓	✓	✓	✓	✓		✓		✓
<b>Option 4</b> Controller Part no. 108232 Control card Part no. 108252	✓	✓	✓	✓	✓	✓	✓	✓	✓	✓	✓		✓
<b>Option 5</b> Controller Part no. 108232 Control card Part no. 108262	✓	✓	✓	✓	✓	✓	✓	✓	✓	✓	✓	✓	✓

Power Cables

Europe Part no. 396853

UK Part no. 396843

USA Part no. 459323











## Fastening Assurance System (FAS)

The Desoutter fastening assurance system provides the ability to verify that all the fasteners in an assembly have been correctly fastened.



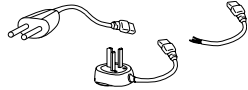

By comparing the timing of electrical signals from the screwdriver with set parameters, the fastening cycle can be monitored and output signals generated for OK and NOK assembly confirmation. The output signals can then be combined to indicate that all the fasteners on the component have been tightened correctly.





## Accessories – Product Specific

	TOOL TYPES	PART NUMBER	DESCRIPTION
	D Series	278373	71mm long
	Straight and	278383	78mm long
	Angle Head	278393	87mm long
	Tools	278403	105mm long
			<b>Soft grip sleeve</b> for operator comfort
	SC-A/L	70442	<b>Side handle</b>
	D Series	70442	For applications above 4Nm on straight case
	SD-A/L	467033	tools and 10Nm on pistol grip tools
	2F	288043	
	2A89	280903	<b>Suspension bail</b> (supplied with tool)
	SB	443703	
	SBP	307683	
	SC-A/L	39433/280893	
	SCP	307683	
	2D/D	39433	
	SD-A/L	467003	
	S4	280893	
S5	436223		
	SC-A/L	95842	<b>Suspension shackle</b> for horizontal tool suspension
	D/2D-A/L	70082	
	2F89	69952	
	H/4H	70042	
	H489-200	69942	
	D/2D-A/L	77722	<b>Offset exhaust</b> with 1/4" BSP silencer which can be removed to pipe the exhaust away
	S5	82162	<b>Operating lever</b> – factory fitted only
	SME	438743	<b>Pistol grip</b>
	SME	438963	<b>Clutch locking ring</b> to make the clutch adjustment tamperproof
	SME	438713	<b>Power Cable</b> (UK)
	SME	438723	<b>Power Cable</b> (Europe)
	SME	438733	<b>Power Cable</b> (flying lead – not for Europe)
			(Appropriate cable supplied with tool)
	SB	108892	<b>Vacuum pick-up attachments</b>
	S5/SC	75152	1/4" hex (F6.3)
	S5/SC	74762	1/4" hex (F6.3)
			5/16" hex
			(includes 1.5m of 4mm hose)
	SB	464103	Finder Sleeve Blank – Plastic
	SB	464093	Finder Sleeve Blank – Steel
S5/SC	464753	Finder Sleeve Blank – Steel	

## Accessories – Angle Heads and Adaptors

TOOL TYPES	PART NUMBER	DESCRIPTION	
		<b>90° Angle Head, 1/4" hex insert (D6.3) output</b>	
		A B (mm) C (mm)	
SC	437833	1/4"/5/16" 36 9.5	
S5	91502	1/4"/5/16" 36 9.5	
		<b>90° Angle Head, 1/4" square output</b>	
		A B (mm) C (mm)	
SC	437843	1/4"/5/16" 31 10	
S5	91492	1/4"/5/16" 33 9.5	
		<b>45° Angle Head, 1/4" hex insert (D6.3) output</b>	
		A – 1/4"/5/16"	
SC/S5	91532		
		<b>45° Angle Head, 1/4" square output</b>	
		A – 1/4"/5/16"	
SC/S5	91522		

Desoutter recommends a steel clutch case with SC screwdrivers when fitting an angle head.  
Maximum torques: SC/S5 types – 4.5Nm

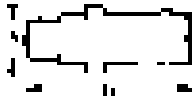
TOOL TYPES	PART NUMBER	DESCRIPTION	
		<b>Integral hexagon drive</b>	
		10mm A/F	
2D472	70872	13mm A/F	
2D4872	70902	0.445" A/F (supplied with tool)	
	9742	0.500" A/F	
	9752		
		<b>Square drive adaptor</b>	
		For use with part no. 9742	
2D472	14392		
2D4872			
		<b>Square drive adaptor</b>	
		A B (mm)	
H410	14422	3/8" 48	
	14442	1/2" 46	
	14482	1/2" 76	

# Accessories – Suspension Balancers and Holster

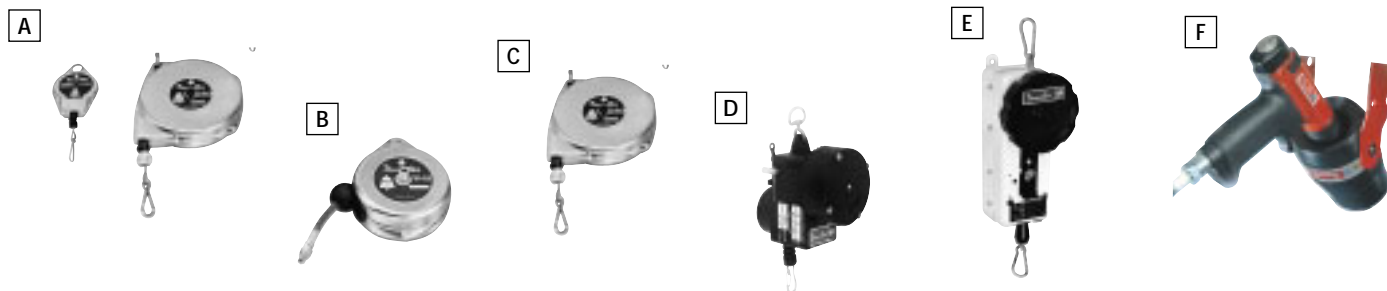

## SPRING SUSPENSION BALANCERS

PICTURE REF	TOOL TYPE	PART NUMBER	CAPACITY MINIMUM	CAPACITY MAXIMUM	CABLE TRAVEL	WEIGHT	OVERALL LENGTH
			kg	kg			
A	1DU	52542	0	0.5	1.5	0.6	230
A	2DU	50522	0.5	1	1.5	0.6	230
A	3DU	52862	0.5	1.5	1.5	0.6	230
A	4DU	50532	1	2	1.5	0.6	230
A	5DU	50542	1.4	2.4	1.5	0.6	230
A	10D	50052	2	5	2.4	2.7	369
A	15D	50062	5	7	2.4	3.2	369
A	22D	50072	6	10	2.4	3.2	369

Additional support chain fitted as standard

## HOSE REEL SUSPENSION BALANCERS

PICTURE REF	TOOL TYPE	PART NUMBER	CAPACITY MINIMUM	CAPACITY MAXIMUM	FLOW RATE	HOSE TRAVEL	WEIGHT	LENGTH
			kg	kg	l/s			
B	1HU	52552	0	0.5	7.1	1.5	1.2	173
B	3HU	50552	0.5	1.4	7.1	1.25	1.2	173
B	4HU	50562	0.7	2	7.1	1.25	1.4	173
B	4HI	51722	0.7	2	9.3	1.00	1.4	173

Additional support chain fitted as standard

### Pistol grip hose reel balancer conversion kit

3HU and 4HU Balancers – Part No. 107403

4HI Balancer – Part No. 115193

## SPRING SUSPENSION SELF-LOCK BALANCERS

PICTURE REF	TOOL TYPE	PART NUMBER	CAPACITY MINIMUM	CAPACITY MAXIMUM	CABLE TRAVEL	WEIGHT	OVERALL LENGTH
			kg	kg			
C	105	50572	2	5	2.4	2.7	369
C	155	50582	5	7	2.4	3.2	369
C	225	50592	6	10	2.4	3.2	369

Additional support chain fitted as standard

## REACTION FREE SELF-LOCK BALANCERS

PICTURE REF	TOOL TYPE	PART NUMBER	CAPACITY MINIMUM	CAPACITY MAXIMUM	CABLE TRAVEL	WEIGHT	OVERALL LENGTH
			kg	kg			
D	2R	54422	0.7	1.3	1.7	0.5	124
D	4R	54432	1	2	1.7	0.5	313
E	5R	54442	1.7	3.5	2.4	2.3	313
E	10R	54452	3	6	2.4	2.3	313

For increased safety use of an additional support chain is advised

## TOOL HOLSTER

PICTURE REF	TOOL TYPE	PART NUMBER	ADJUSTING ANGLE	INTERNAL DIAMETER	EXTERNAL DIAMETER	TOTAL WIDTH	WEIGHT	HEIGHT
				mm	mm			
F	DTH-42	107892	140°	42	87	116	0.9	130

# Accessories – Stands

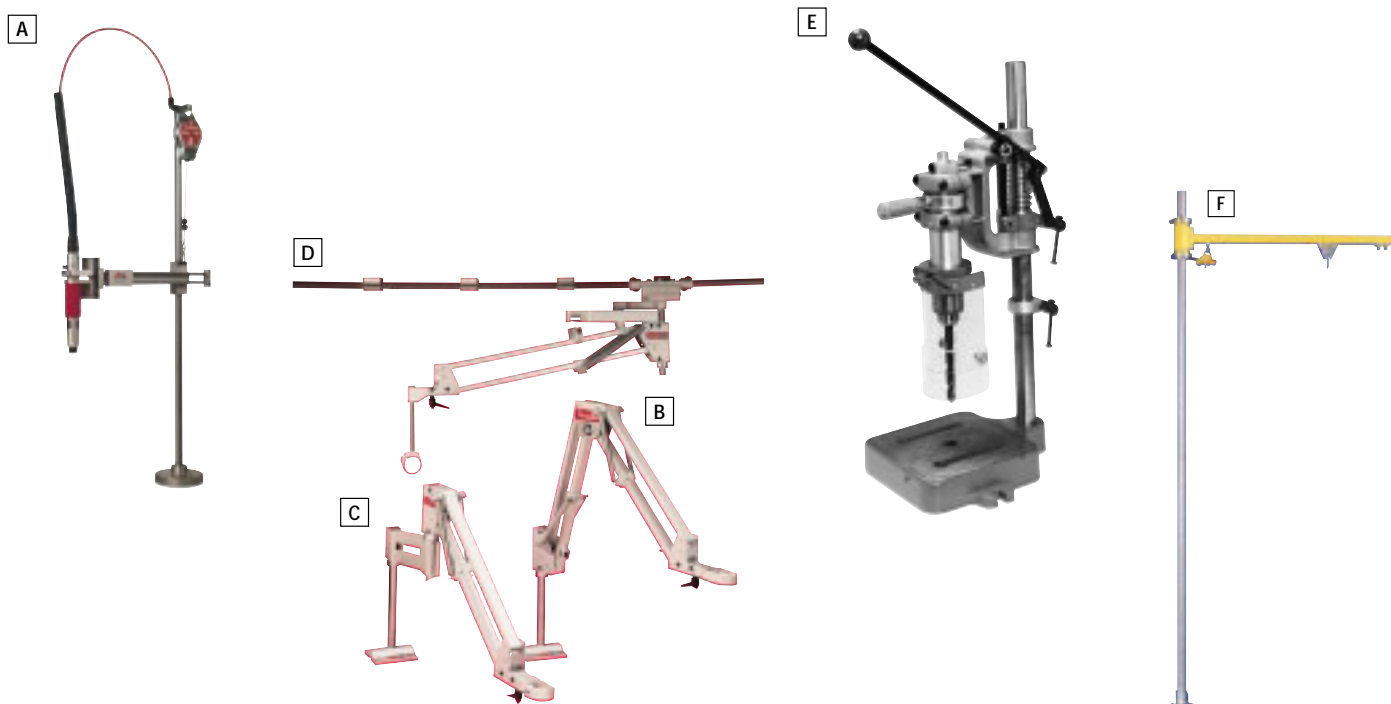

## BENCH STANDS

PICTURE REF	TYPE	HEIGHT	MAXIMUM VERTICAL STROKE	MINIMUM REACH	MAXIMUM REACH	CLAMP RANGE
			mm	mm	mm	mm
A	D53	1130	600	220	580	26-38
A	D53X	1130	600	175	680	26-38

## BALANCING ARMS

PICTURE REF	TYPE	TYPE	MAXIMUM VERTICAL STROKE	MINIMUM REACH	MAXIMUM REACH	CLAMP RANGE
			mm	mm	mm	mm
B	D57	Pantograph	-	400	700	25-56
B	D57X	Pantograph	-	450	850	25-56
C	D58	Pantograph with swivel point in the centre of the arm	-	500	750	25-56
D	D59	Rail mounted arm	300	565	650	25-56

## LEVER OPERATED STANDS

PICTURE REF	TYPE	HEIGHT	WIDTH	DEPTH	MAXIMUM VERTICAL STROKE	CLAMP SIZE
			mm	mm	mm	mm
E	D54	405	240	205	45	36
E	R55S	610	270	245	57	Flat face

## BENCH MOUNTED SWINGING ARM

PICTURE REF	TYPE	HEIGHT	HORIZONTAL STROKE	CAPACITY
		mm	mm	kg
F	66542	1600	500	10

## BENCH TIDY

The Desoutter range of accessories also include Bench Tidy, a versatile system of uprights and tracking designed to suspend a tools, present components and ensure the workplace is clean.

Ask for further details please ask for Installation Accessories Catalogue part number LT1394.

# Accessories – Torque Measurement

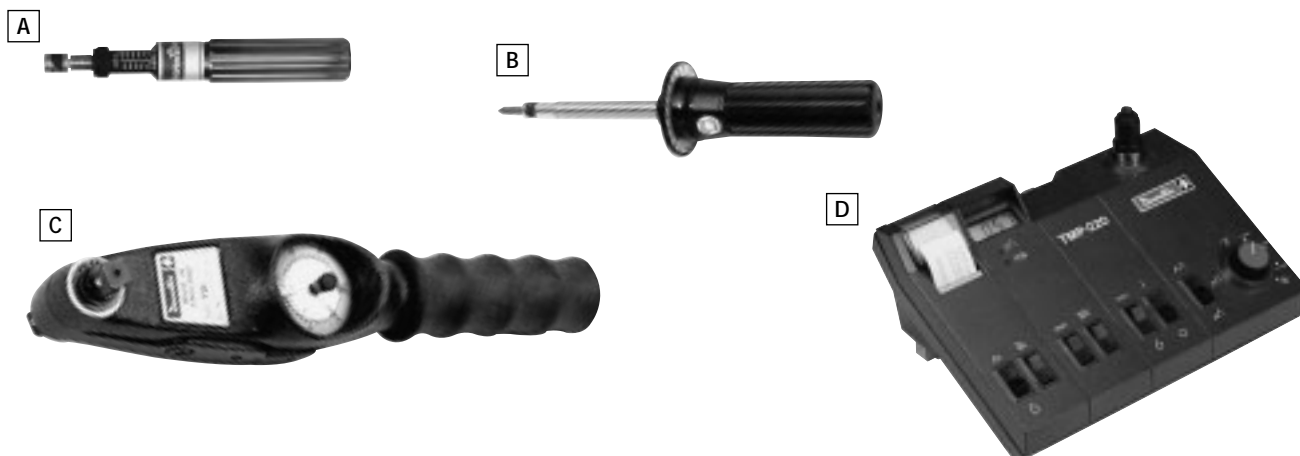

## PRESET TORQUE ADJUSTABLE SCREWDRIVERS – FOR TIGHTENING

PICTURE REF	TOOL TYPE	PART NUMBER	TORQUE RANGE		INCREMENTS		OUTPUT	LENGTH	WEIGHT
			metric	imperial	metric	imperial			
A	AS-120	81892	10-120 cNm	–	1 cNm	–	1/4" fem. hex.	168	0.16
A	AS-600 <sup>1)</sup>	81922	1-6 Nm	–	0.1 Nm	–	1/4" fem. hex.	184	0.34
A	AS-900 <sup>1)</sup>	81942	4-9 Nm	–	0.1 Nm	–	1/4" fem. hex.	184	0.34
A	AS-07	81902	–	10-120 ozf in	–	1 ozf in	1/4" fem. hex.	168	0.16
A	AS-50 <sup>1)</sup>	81932	–	5-50 lbf in	–	1 lbf in	1/4" fem. hex.	184	0.34
A	AS-80 <sup>1)</sup>	81952	–	40-80 lbf in	–	1 lbf in	1/4" fem. hex.	184	0.34

<sup>1)</sup> Supplied with 'T' bar

## DIAL INDICATING TORQUE SCREWDRIVERS – FOR MEASURING + TIGHTENING

PICTURE REF	TOOL TYPE	PART NUMBER	TORQUE RANGE		INCREMENTS		OUTPUT	LENGTH	WEIGHT
			metric	imperial	metric	imperial			
B	TS-050	81852	0-50 cNm	0-70 ozf in	2 cNm	5 ozf in	1/4" fem. hex.	178	0.2
B	TS-100	81862	0-100 cNm	0-140 ozf in	5 cNm	10 ozf in	1/4" fem. hex.	178	0.2
B	TS-250 <sup>1)</sup>	81872	0-250 cNm	0-20 lbf in	10 cNm	1 lbf in	1/4" fem. hex.	250	0.5
B	TS-500 <sup>1)</sup>	81882	0-500 cNm	0-40 lbf in	20 cNm	2 lbf in	1/4" fem. hex.	250	0.5

<sup>1)</sup> Supplied with 'T' bar

## DIAL INDICATING TORQUE WRENCHES – FOR MEASURING + TIGHTENING

PICTURE REF	TOOL TYPE	PART NUMBER	TORQUE RANGE		INCREMENTS		OUTPUT	LENGTH	WEIGHT	A	B
			metric	imperial	metric	imperial					
C	TW-4	81962	0.3-4 Nm	3-35 lbf in	0.1 Nm	1 lbf in	1/4" sq	255	0.52	11	54
C	TW-13	81972	0.5-13.5 Nm	4-120 lbf in	0.5 Nm	2 lbf in	3/8" sq	255	0.52	11	58
C	TW-27	81982	1-27 Nm	1-20 lbf ft	1 Nm	0.5 lbf ft	3/8" sq	255	0.52	11	58
C	TW-80	81992	6-80 Nm	5-60 lbf ft	2 Nm	1 lbf ft	1/2" sq	455	1.36	20	75
C	TW-160	82002	10-160 Nm	6-120 lbf ft	2.5 Nm	2 lbf ft	1/2" sq	535	1.36	20	75

## TMP220 BENCH TOP TORQUE METER

PICTURE REF	TORQUE RANGE	NICAD BATTERIES	APPROX BATTERY LIFE	CHARGING TIME	WEIGHT	DIMENSIONS	120V CHARGER	230V CHARGER	230V CHARGER
							(USA)	(EUROPE)	(UK)
D	0-1Nm/0-10 Nm	4 x 1.2V	8	10	3.2	290x195x115	54382	54372	54362

Suitable for ratchet tools and shut off tools up to 10Nm (100 inf lbs)

- Switchable for first peak, max. peak and continuous monitoring
- Accuracy  $\pm 0.5\%$  of full scale
- Switchable metric or imperial torque readout
- RS232 output for data recording by computer

- Lightweight and compact, supplied with charger
- Joint simulator kit supplied – part no. 54392
- Vice bar fitted for rigid mounting
- Printer paper part no. 345953 – order separately
- To order spare charger 120v (USA) part no. 345623, 220v (Europe) part no. 345613, 240v (UK) part no. 345603



### SIGMA 2001 – MEASURING UNIT

- Maximum peak or continuous monitoring
- Multilingual programming in French, English, German, Spanish
- Integral CdNi rechargeable battery
- Approximately 8 hour battery life
- For use with static and dynamic transducers
- Sensitivity 0.5-2.5mV/V

- Transducer load 1-10,000 Nm
- Function to allow joint type to be selected (hard/standard/ soft/breakaway)
- Special mode for measuring impulse tools
- Memory, up to 1000 results including torque, date and time
- Data can be downloaded to a printer or PC

### DELTA 4000 – MEASURING UNIT

- As per SIGMA 2001 plus
- LED's for OK, below minimum torque, above maximum torque
- Inputs to permit resetting and storing/not storing a result
- Outputs for OK, below minimum torque, above maximum torque, torque reached and analog torque output

- Memory, up to 5000 results including torque, date, time and one curve that can be displayed on a PC
- Up to 1000 parameter sets can be stored
- Statistics, ISO and CNOMO:CAM, CPK, Mean, Standard Deviation ...

Full details of the Georges Renault range of measuring equipment can be found in other catalogues. Please ask for details.

## Accessories



Insert bits (C6.3) and adaptors



Power bits (E6.3 and 5/16")



Power bits and finder sleeves (E6.3 and 5/16")

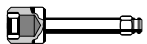

Nutrunners (E6.3 and 5/16")



Sockets (1/4", 3/8", 1/2") and adaptors



- Air preparation units
- Filter/regulator, lubricators
- Filter, regulator, lubricators
- Filters
- Filter/regulators
- Regulators
- Lubricators



- Reinforced pvc air hose
- Coiled hose

- Quick release couplers
- Quick release nipples
- Thread adaptors

Full details of the Desoutter range of accessories can be found in the catalogues detailed below.

### 1.1 Consumables

- Screwdriver Bits
- Suction Screw Pick-up
- Impulse/Impact Bits
- Bit holders
- Adaptors
- Nutrunners
- Bottle Cap Drivers
- Sockets
- Stud Runners

Part No. LT1391



### 1.2 Installation

- Air Supply and Preparation Equipment
- Stands
- Balancers
- Bench Tidy

Part No. LT1394

Due to be  
released later  
this year

# Screwfeeders and Torque Motors

## Screwfeeders



For applications where productivity is of importance the use of a screwfeeder can dramatically reduce the fastening cycle time.

The range of Desoutter Screw Feeding Systems are capable of operation with hand operated and fixtured screwdrivers.

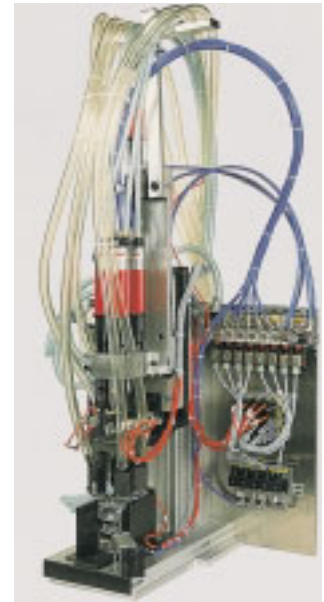

Ask for further details from your local sales contact.

## Torque Motors

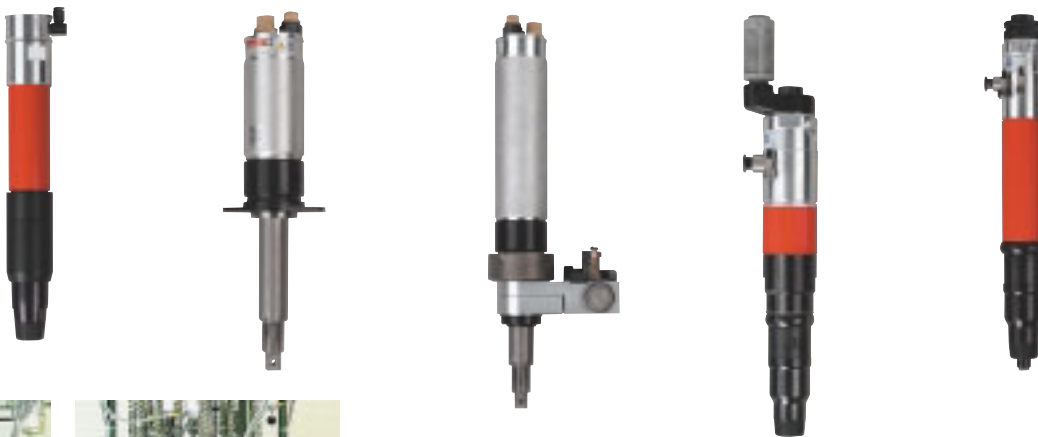

The Desoutter range of torque motors are for use in fixtures, stands or multiple units. The range comprises:

TYPE	CONTROL	TORQUE RANGE
		Nm
System 100	Stall Torque	2-175
System 200	Minimum Torque Indication	14-175
System 300	Indicated Torque Control	14-175
Shut Off	Torque Controlled Shut Off	0.4-32

Please ask for further details from your local sales contact.

# Other Products

Drills



Pneumatic Motors



Auto Feed Drills and Tappers



Impact Wrenches



Installation Accessories

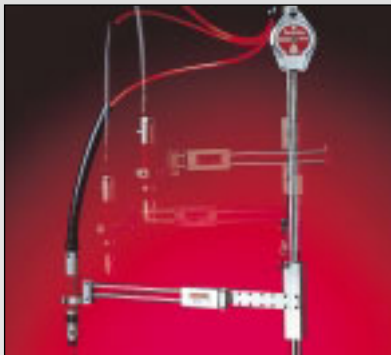

Riveting Tools



Vertical Grinders



Grinders



Sanders



Measuring Units



Electric Nutrunners



Assembly Systems

