

Grinders for carbide burrs, mounted points and sanding discs

375 Watts (0.5 hp) - 12 000 to 40 000 rpm

Supplied with CNOMO collet, \varnothing 6 mm



A



B



C



D

Lou Zampini & Associates

2 Douglas Pike, Rt. 7

Smithfield, RI 02917

1 800 353 4676

FAX 1 401 679 0165

K3..-7 / KC3..-7 / KA3..E7 / KA3..-7
CNOMO type collet



Caution: comply with the speeds recommended by component and abrasive manufacturers

PICTURE REF	MODEL	PART NUMBER	FREE SPEED	COLLET MAX CAPACITY	POWER		WEIGHT		AIR CONSUMPTION				AIR INLET THREAD	HOSE INT. Ø
					W	hp	kg	lb.	AT FREE SPEED	AT MAX OUTPUT	INCH	MM		
			rpm	mm					l/s	cfm	l/s	cfm	inch	mm
STRAIGHT GRINDERS														
A	K340-7	615 170 036 0	40000	6.4	375	0.5	0.58	1.28	7.5	16.0	10.0	21	1/4	8
A	K331-7	615 170 035 0	31000	6.4	375	0.5	0.58	1.28	4.5	9.5	9.5	20	1/4	8
A	K325-7	615 170 034 0	25000	6.4	375	0.5	0.58	1.28	3.5	7.5	9.5	20	1/4	8
A	K320-7	615 170 033 0	20000	6.4	375	0.5	0.58	1.28	2.5	5.0	8.0	17	1/4	8
B	KC340-7	615 170 032 0	40000	6.4	375	0.5	0.40	0.88	7.5	16.0	10.0	21	1/4	8
B	KC331-7	615 170 031 0	31000	6.4	375	0.5	0.40	0.88	4.5	9.5	9.5	20	1/4	8
B	KC325-7	615 170 030 0	25000	6.4	375	0.5	0.40	0.88	3.5	7.5	9.5	20	1/4	8
B	KC320-7	615 170 029 0	20000	6.4	375	0.5	0.40	0.88	2.5	5.0	8.0	17	1/4	8
ANGLE GRINDERS														
C	KA320E7	615 170 047 0	20000	6.4	375	0.5	0.60	1.32	6.5	13.5	10.0	21	1/4	8
C	KA312E7	615 170 039 0	12000	6.4	375	0.5	0.60	1.32	3.0	6.5	9.0	19	1/4	8
D	KA320-7	615 170 043 0	20000	6.4	375	0.5	0.50	1.10	6.5	13.5	10.0	21	1/4	8
D	KA312-7	615 170 037 0	12000	6.4	375	0.5	0.50	1.10	3.0	6.5	9.0	19	1/4	8

Grinders for carbide burrs and mounted points

600 - 900 Watts (0.8 - 1.21 hp) - 12 000 to 28 000 rpm

Supplied with CNOMO collet, \varnothing 6 mm



A



B



C



D

K6..-7 / KC6..-7 / K9..-7 / KC9..-7
CNOMO type collet



Caution: comply with the speeds recommended by component and abrasive manufacturers

PICTURE REF	MODEL	PART NUMBER	FREE	COLLET	POWER		WEIGHT		AIR CONSUMPTION				AIR	HOSE
			SPEED	MAX CAPACITY	W	hp	kg	lb.	AT FREE SPEED	AT MAX OUTPUT	INLET THREAD	INT. Ø		
			rpm	mm					l/s	cfm	l/s	cfm	inch	mm
A	K628-7	615 170 107 0	28000	8	600	0.80	1.3	2.9	16	34	15	32	3/8	10
A	K624-7	615 170 106 0	24000	8	600	0.80	1.3	2.9	10	21	15	32	3/8	10
A	K922-7	615 170 119 0	22000	8	900	1.21	1.4	3.1	13	28	18	38	3/8	10
A	K619-7	615 170 105 0	19000	8	600	0.80	1.3	2.9	6	13	15	32	3/8	10
A	K918-7	615 170 117 0	18000	8	900	1.21	1.4	3.1	10	21	18	38	3/8	10
A	K615-7	615 170 104 0	15000	8	600	0.80	1.3	2.9	6	13	15	32	3/8	10
A	K915-7	615 170 114 0	15000	8	900	1.21	1.4	3.1	8	17	17	36	3/8	10
A	K912-7	615 170 110 0	12000	8	900	1.21	1.4	3.1	6	13	16	34	3/8	10
B	KC628-7	615 170 126 0	28000	8	600	0.80	0.9	2.0	16	34	15	32	3/8	10
B	KC624-7	615 170 125 0	24000	8	600	0.80	0.9	2.0	10	21	15	32	3/8	10
B	KC922-7	615 170 130 0	22000	8	900	1.21	1.0	2.2	13	28	18	38	3/8	10
B	KC619-7	615 170 124 0	19000	8	600	0.80	0.9	2.0	6	13	15	32	3/8	10
B	KC918-7	615 170 129 0	18000	8	900	1.21	1.0	2.2	10	21	18	38	3/8	10
B	KC615-7	615 170 123 0	15000	8	600	0.80	0.9	2.0	6	13	15	32	3/8	10
B	KC915-7	615 170 128 0	15000	8	900	1.21	1.0	2.2	8	17	17	36	3/8	10
B	KC912-7	615 170 127 0	12000	8	900	1.21	1.0	2.2	6	13	16	34	3/8	10
C	K912-300-7	615 170 108 0	12000	8	900	1.21	2.1	4.6	6	13	16	34	3/8	10
D	K912-500-7	615 170 109 0	12000	8	900	1.21	2.7	5.9	6	13	16	34	3/8	10

Accessories

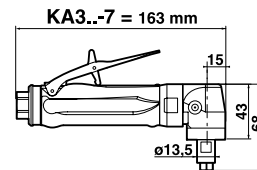
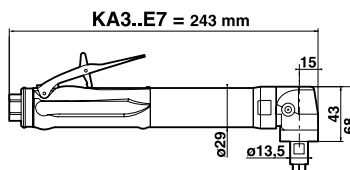
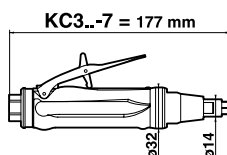
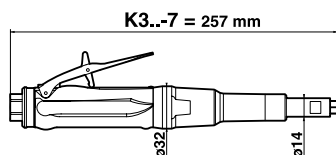

K3.-7 / KC3.-7 / KA3..E7 / KA3.-7

ACCESSORIES INCLUDED

	PART NO.
• CNOMO collet ϕ 6 mm	615 526 046 0
• Exhaust hose L = 0.8m (31")	615 875 106 0
• 1/4" air hose nipple for 8 mm ID hose	615 704 019 0
• Flat wrench, 10 mm (25/64")	615 801 002 0
• Flat wrench, 11 mm (7/16")	615 801 003 0

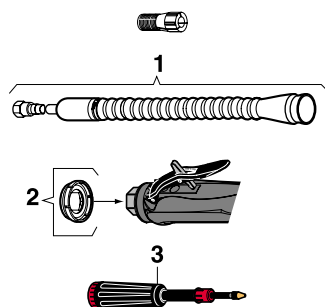
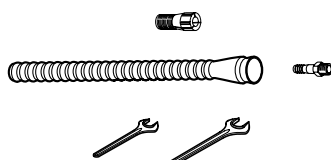

OPTIONAL ACCESSORIES

ITEM	PART NO.
• CNOMO collet ϕ 2.5 mm	615 526 089 0
• CNOMO collet ϕ 3 mm	615 526 044 0
• CNOMO collet ϕ 3.2 mm (1/8")	615 526 045 0
• CNOMO collet ϕ 4 mm (5/32")	615 526 090 0
• CNOMO collet ϕ 4.5 mm	615 526 091 0
• CNOMO collet ϕ 5 mm	615 526 092 0
• CNOMO collet ϕ 6.4 mm (1/4")	615 526 047 0
1 Complete silencer kit	615 396 101 0
2 Clipable silencer	615 396 124 0
3 Grease gun (capacity 24 g.)	615 990 149 0
• Lubricant for bevel gear (1 kg)	615 990 148 0



Accessories

K6..-7 / K9..-7 = 363 mm

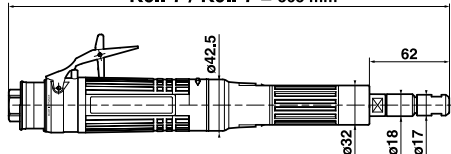

KC6..-7 / KC9..-7 = 222 mm

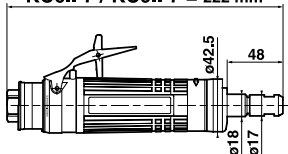

K912-300-7 = 603 mm

K912-500-7 = 853 mm

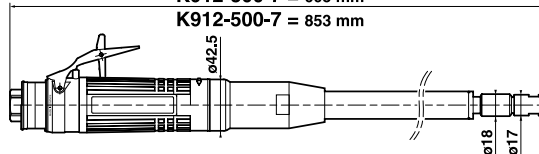

K6..-7 / K9..-7 / KC6..-7 / KC9..-7

ACCESSORIES INCLUDED

	PART NO.
• CNOMO collet \varnothing 6 mm	615 526 049 0
• Exhaust hose L = 1.5 m (60")	615 875 113 0
• Clamp	615 873 415 0
• 3/8" air hose nipple for 10 mm ID hose	615 704 017 0
• Flat wrench, 14 mm (Qty 2)	615 801 005 0

OPTIONAL ACCESSORIES

ITEM	PART NO.
• Collet-holder extension L = 28 mm	615 523 019 0
• CNOMO collet \varnothing 3 mm	615 526 048 0
• CNOMO collet \varnothing 6.35 mm (1/4")	615 526 050 0
• CNOMO collet \varnothing 8 mm	615 526 051 0
1 Complete silencer kit	615 396 166 0
2 Inlet hose assembly L = 1.7 m (67") 3/8"M - 3/8"F - \varnothing 10 mm	615 870 210 0
3 Reinforced cloth-lined exhaust hose L = 0.75 m (30")	615 875 116 0

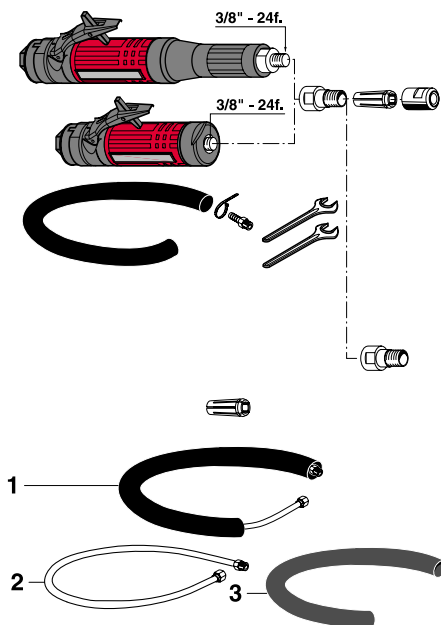

Accessories

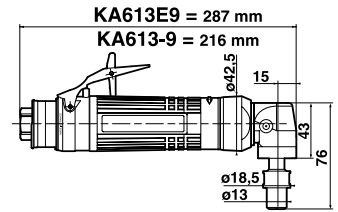
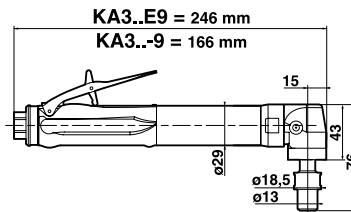
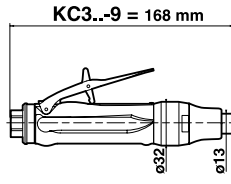
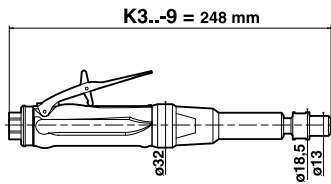

K3..-9 / KC3..-9 / KA3..E9 / KA3..-9 / KA613E9 / KA613-9

ACCESSORIES INCLUDED

	KA613E9	K3../KC3..-9
	KA613-9	KA3..E9/KA3..-9
• Series 300 resilient collet, \varnothing 5.55 to 6.35 mm (1/4")	615 526 059 0	615 526 059 0
• Exhaust hose L = 0.8 m (31")	-	615 875 106 0
• Exhaust hose L = 1.5 m (60")	615 875 113 0	-
• Clamp	615 873 415 0	-
• 1/4" air hose nipple for 8 mm ID hose	-	615 704 019 0
• 3/8" air hose nipple for 10 mm ID hose	615 704 017 0	-
• Flat wrench, 11 mm (7/16")	615 801 003 0	615 801 003 0
• Flat wrench, 17 mm (11/16")	615 801 032 0	615 801 032 0

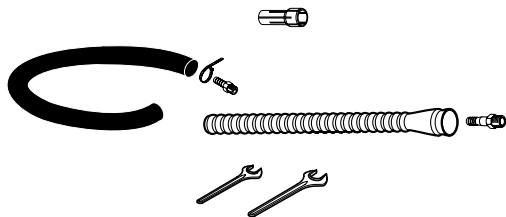

OPTIONAL ACCESSORIES

ITEM	KA613E9	K3../KC3..-9
	KA613-9	KA3..E9/KA3..-9
• Series 300 resilient collet, \varnothing 0.4 to 1.2 mm	615 526 052 0	615 526 052 0
• Series 300 resilient collet, \varnothing 1.2 to 2 mm	615 526 053 0	615 526 053 0
• Series 300 resilient collet, \varnothing 1.7 to 2.5 mm	615 526 054 0	615 526 054 0
• Series 300 resilient collet, \varnothing 2.4 to 3.2 mm (1/8")	615 526 055 0	615 526 055 0
• Series 300 resilient collet, \varnothing 3.16 to 3.96 mm	615 526 056 0	615 526 056 0
• Series 300 resilient collet, \varnothing 3.95 to 4.75 mm	615 526 057 0	615 526 057 0
• Series 300 resilient collet, \varnothing 4.75 to 5.55 mm	615 526 058 0	615 526 058 0
1 Complete silencer kit	615 396 166 0	615 396 101 0
2 Clipable silencer	-	615 396 124 0
3 Inlet hose assembly L = 1.7 m (67") 3/8"M - 3/8"F \varnothing 10 mm	615 870 210 0	-
4 Reinforced cloth-lined exhaust hose L = 0.75 m (30")	615 875 116 0	-
5 Grease gun (capacity 24 g.)	615 990 149 0	615 990 149 0
• Lubricant for bevel gear (1 kg)	615 990 148 0	615 990 148 0

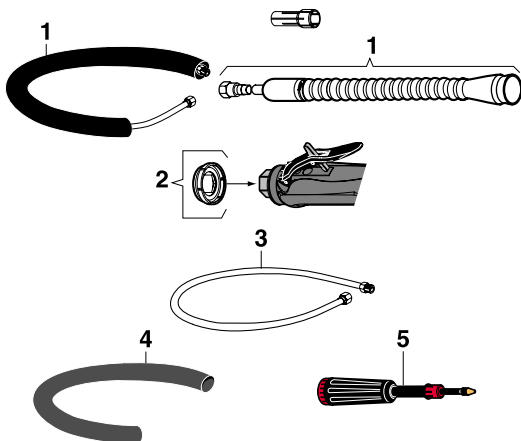

PLANING DOWN WELD



SEMI-FINISH/FINISH



TRIMMING



CLEANING



TRIMMING - MACHINING



GRINDING

Grinders for carbide burrs, mounted points and sanding discs

375 - 600 Watts (0.5 - 0.8 hp) - 12 000 to 40 000 rpm

Supplied with series 300 resilient collet, \varnothing 5.55 to 6.35 mm (1/4")



K3..-9 / KC3..-9 / KA3..(E)9 / KA613(E)9
Series 300 collet



Caution: comply with the speeds recommended by component and abrasive manufacturers

PICTURE REF	MODEL	PART NUMBER	FREE SPEED	COLLET MAX CAPACITY	POWER		WEIGHT		AIR CONSUMPTION				AIR INLET THREAD	HOSE INT. Ø	
					rpm	mm	W	hp	kg	lb.	AT FREE SPEED	AT MAX OUTPUT			l/s
STRAIGHT GRINDERS															
A	K340-9	615 170 139 0	40000	6.35	375	0.5	0.57	1	.26	7.5	16 .0	100	21	1/4	8
A	K331-9	615 170 140 0	31000	6.35	375	0.5	0.57	1	.26	4.5	9 .5	95	20	1/4	8
A	K325-9	615 170 141 0	25000	6.35	375	0.5	0.57	1	.26	3.5	7 .5	95	20	1/4	8
A	K320-9	615 170 142 0	20000	6.35	375	0.5	0.57	1	.26	2.5	5 .0	80	17	1/4	8
B	KC340-9	615 170 143 0	40000	6.35	375	0.5	0.38	0	.84	7.5	16 .0	100	21	1/4	8
B	KC331-9	615 170 144 0	31000	6.35	375	0.5	0.38	0	.84	4.5	9 .5	95	20	1/4	8
B	KC325-9	615 170 145 0	25000	6.35	375	0.5	0.38	0	.84	3.5	7 .5	95	20	1/4	8
B	KC320-9	615 170 027 0	20000	6.35	375	0.5	0.38	0	.84	2.5	5 .0	80	17	1/4	8
B	KC318-9	615 170 196 0	18000	6.35	375	0.5	0.38	0	.84	2.5	5 .0	80	17	1/4	8
ANGLE GRINDERS															
C	KA320E9	615 170 146 0	20000	6.35	375	0.5	0.61	1	.35	6.5	13 .5	100	21	1/4	8
C	KA312E9	615 170 147 0	12000	6.35	375	0.5	0.61	1	.35	3.0	6 .5	90	19	1/4	8
D	KA320-9	615 170 148 0	20000	6.35	375	0.5	0.51	1	.13	6.5	13 .5	100	21	1/4	8
D	KA312-9	615 170 149 0	12000	6.35	375	0.5	0.51	1	.13	3.0	6 .5	90	19	1/4	8
E	KA613E9	615 170 136 0	13000	6.35	600	0.8	1.40	3	.10	100	21.0	150	3 2	3/8	10
F	KA613-9	615 170 135 0	13000	6.35	600	0.8	1.10	2	.40	100	21.0	150	32	3/8	10

Accessories

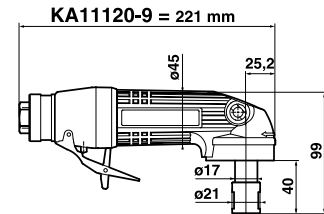
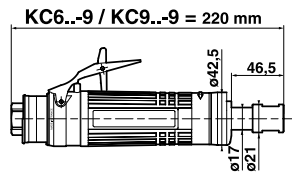
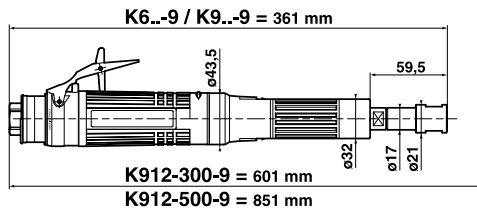

K6..-9 / K9..-9 / KC6..-9 / KC9..-9 / KA11120-9

ACCESSORIES INCLUDED

	PART NO.
• Series 200 resilient collet, ø 5.55 to 6.35 mm (1/4")	615 526 063 0
• Exhaust hose L = 1.5 m (60")	615 875 113 0
• Clamp	615 873 415 0
• 3/8" air hose nipple for 10 mm ID hose	615 704 017 0
• 3/8" air hose nipple for 13 mm ID hose for KA11120-9	616 704 027 0
• Flat wrench, 14 mm	615 801 005 0
• Flat wrench, 19 mm (3/4")	615 801 076 0
• Side handle for KA11120-9	615 576 038 0

OPTIONAL ACCESSORIES

ITEM	PART NO.
• Series 200 resilient collet, ø 2.4 to 3.2 mm (1/8")	615 526 061 0
• Series 200 resilient collet, ø 5.2 to 6 mm	615 526 062 0
• Series 200 resilient collet, ø 7.2 to 8 mm	615 526 064 0
• Series 200 resilient collet, ø 8.7 to 9.5 mm (3/8")	615 526 065 0
1 Vibration-damping handle for KA11120-9	615 576 066 0
2 Insulating sleeve for KA11120-9	615 570 412 0
3 Complete silencer kit	615 396 166 0
4 Inlet hose assembly L = 1.7 m (67") 3/8"M - 3/8"F - ø 10 mm	615 870 210 0
4 Inlet hose assembly L = 1.7 m (67") 3/8"M - 3/8"F ø 13 mm for KA11120-9	615 804 064 0
5 Reinforced cloth-lined exhaust hose L = 0.75 m (30")	615 875 116 0

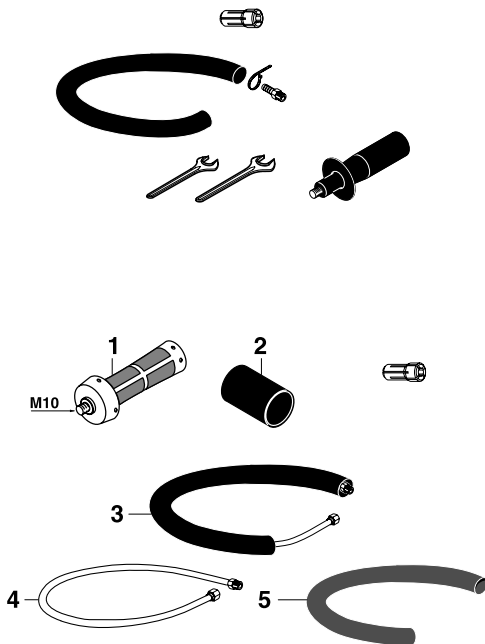

Grinders for carbide burrs, mounted points and sanding discs

600 to 1100 Watts (0.8 to 1.5 hp) - 12 000 to 28 000 rpm

Supplied with series 200 resilient collet, \varnothing 5.55 to 6.35 mm (1/4")



A



B



C



D



E

K6..-9 / K9..-9 / KC6..9 / KC9..9 / KA11120-9

Series 200 collet



Caution: comply with the speeds recommended by component and abrasive manufacturers

PICTURE REF	MODEL	PART NUMBER	FREE	COLLET MAX CAPACITY	POWER		WEIGHT		AIR CONSUMPTION				AIR	HOSE
			SPEED		W	hp	kg	lb.	AT FREE SPEED	AT MAX OUTPUT	INLET THREAD	INT. Ø		
			rpm	mm					l/s	cfm	l/s	cfm	inch	mm
A	K628-9	615 170 1500	28000	9.5	600	0.80	1.3	2.9	16	34	15	32	3/8	10
A	K624-9	615 170 1510	24000	9.5	600	0.80	1.3	2.9	10	21	15	32	3/8	10
A	K922-9	615 170 1520	22000	9.5	900	1.21	1.4	3.1	13	28	18	38	3/8	10
A	K619-9	615 170 1530	19000	9.5	600	0.80	1.3	2.9	6	13	15	32	3/8	10
A	K918-9	615 170 1540	18000	9.5	900	1.21	1.4	3.1	10	21	18	38	3/8	10
A	K615-9	615 170 1550	15000	9.5	600	0.80	1.3	2.9	6	13	15	32	3/8	10
A	K915-9	615 170 1560	15000	9.5	900	1.21	1.4	3.1	8	17	17	36	3/8	10
A	K912-9	615 170 1570	12000	9.5	900	1.21	1.4	3.1	6	13	16	34	3/8	10
B	KC628-9	615 170 1580	28000	9.5	600	0.80	0.9	2.0	16	34	15	32	3/8	10
B	KC624-9	615 170 1590	24000	9.5	600	0.80	0.9	2.0	10	21	15	32	3/8	10
B	KC922-9	615 170 1600	22000	9.5	900	1.21	1.0	2.2	13	28	18	38	3/8	10
B	KC619-9	615 170 1610	19000	9.5	600	0.80	0.9	2.0	6	13	15	32	3/8	10
B	KC918-9	615 170 1620	18000	9.5	900	1.21	1.0	2.2	10	21	18	38	3/8	10
B	KC615-9	615 170 1630	15000	9.5	600	0.80	0.9	2.0	6	13	15	32	3/8	10
B	KC915-9	615 170 1640	15000	9.5	900	1.21	1.0	2.2	8	17	17	36	3/8	10
B	KC912-9	615 170 1650	12000	9.5	900	1.21	1.0	2.2	6	13	16	34	3/8	10
C	K912-300-9	615 170 1690	12000	9.5	900	1.21	2.1	4.6	6	13	16	34	3/8	10
D	K912-500-9	615 170 1700	12000	9.5	900	1.21	2.7	5.9	6	13	16	34	3/8	10
E	KA11120-9	615 170 0600	12000	9.5	1100	1.50	1.4	3.1	10	21	19	40	3/8	13

Grinders for carbide burrs, mounted points and sanding discs

0.5 hp - 12,000 - 20,000 rpm

Supplied with series 300 resilient collet, \varnothing 1/4" (5.55 to 6.35 mm)

Front Exhaust



A

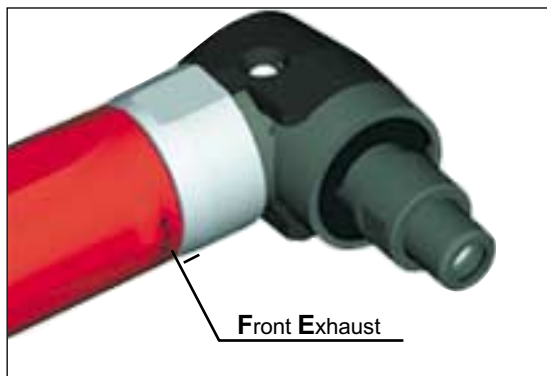

K312-9FE / KA320-9FE
Series 300 collet



WARNING: comply with the speeds recommended by component and abrasive manufacturers

PICTURE REF	MODEL	PART NUMBER	FREE SPEED	COLLET MAX CAPACITY	POWER		WEIGHT		AIR CONSUMPTION				AIR INLET THREAD	HOSE INT \varnothing
					rpm	in.	hp	W	lb.	kg	AT FREE SPEED	AT MAX OUTPUT		
A	KA320-9FE	615 170 206 0	20,000	1/4	0.5	375	1.13	0.51	13.5	6.5	21	10.0	1/4	5/16
A	KA312-9FE	615 170 205 0	12,000	1/4	0.5	375	1.13	0.51	6.5	3.0	19	9.0	1/4	5/16

Accessories

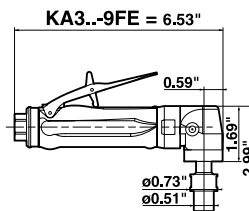

KA320-9FE / KA312-9FE

ACCESSORIES INCLUDED

ITEM	PART NO.
• Series 300 resilient collet, \varnothing 1/4" (5.55 to 6.35 mm)	615 526 059 0
1 1/4" air hose nipple for 5/16" (8 mm) ID hose	615 704 019 0
2 Clip-on silencer	615 396 124 0
• Flat wrench, 7/16" (11 mm)	615 801 003 0
• Flat wrench, 11/16" (17 mm)	615 801 032 0

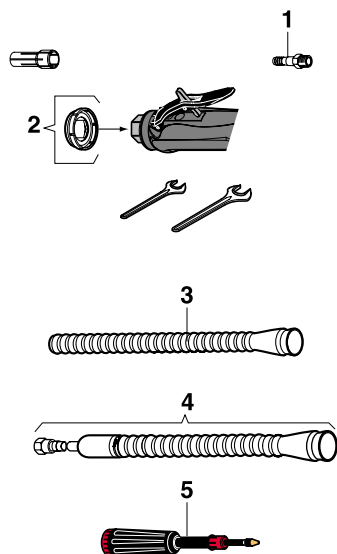

OPTIONAL ACCESSORIES

ITEM	PART NO.
• Series 300 resilient collet, \varnothing 3/64" (0.4 to 1.2 mm)	615 526 052 0
• Series 300 resilient collet, \varnothing 5/64" (1.2 to 2 mm)	615 526 053 0
• Series 300 resilient collet, \varnothing 3/32" (1.7 to 2.5 mm)	615 526 054 0
• Series 300 resilient collet, \varnothing 1/8" (2.4 to 3.2 mm)	615 526 055 0
• Series 300 resilient collet, \varnothing 5/32" (3.16 to 3.96 mm)	615 526 056 0
• Series 300 resilient collet, \varnothing 3/16" (3.95 to 4.75 mm)	615 526 057 0
• Series 300 resilient collet, \varnothing 7/32" (4.75 to 5.55 mm)	615 526 058 0
3 Exhaust hose L = 31" (0.8 m)	615 875 106 0
4 Complete silencer kit	615 396 101 0
5 Grease gun includes 0.8 oz. (24 g)	615 990 149 0
• Grease for bevel gear 2.2 lb. (1 kg)	615 990 148 0



Abrasive accessories

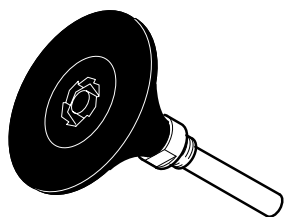

BACKING PAD FOR MECHANICAL MOUNTING DISCS

SPEED rpm	Ø mm	PART NO.
25 000	50	615 804 098 0

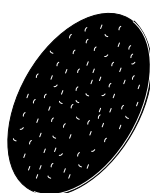

MECHANICAL MOUNTING ABRASIVE DISCS

SPEED rpm	GRIT	PART NO.
25 000	P40	615 804 099 0
25 000	P60	615 804 100 0
25 000	P80	615 804 101 0
25 000	P120	615 804 102 0

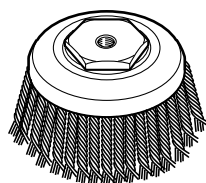

CUP BRUSHES, THREAD 5/8"-11f.

MAX SPEED rpm	Ø mm	TYPE	WIRE Ø mm	PART NO.
6 500	80	Twisted	5/10	615 804 065 0
4 500	100	Undulated	3/10	615 804 073 0
4 500	100	Undulated	5/10	615 804 066 0
6 500	120	Undulated	3/10	615 804 067 0
6 500	120	Twisted	8/10	615 804 068 0
4 500	150	Undulated	3/10	615 804 069 0
4 500	150	Twisted	8/10	615 804 071 0



RADIAL BRUSHES

SPEED MAX rpm	Ø mm	BORE mm	TYPE	WIRE Ø mm	PART NO.
4 500	100	15.8	Undulated	5/10	615 854 155 0
4 500	150	15.8	Undulated	3/10	615 858 153 0

