

Accessories

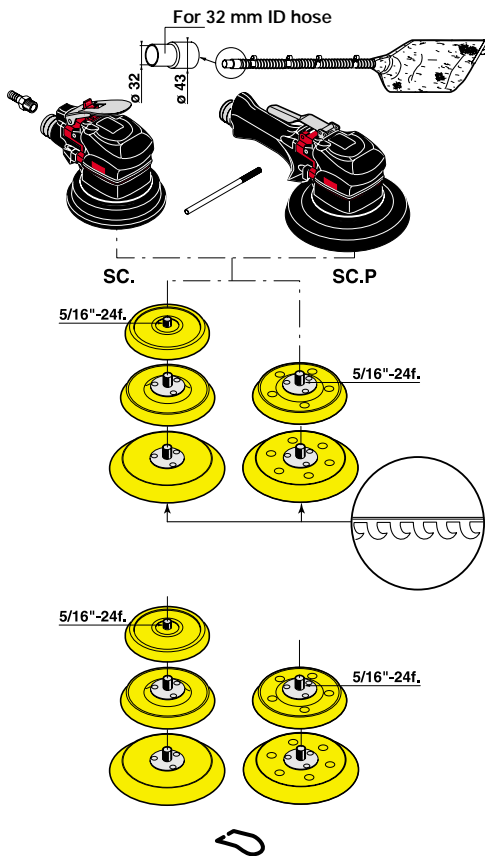
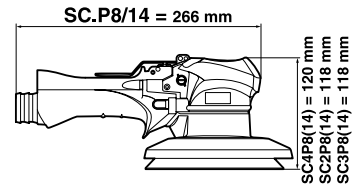
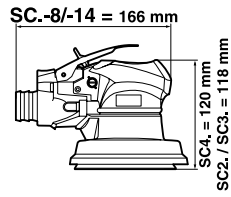
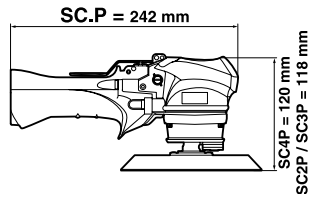
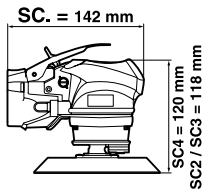

SC.. / SC..P

ACCESSORIES INCLUDED

| | PART NO. |
|--|---------------|
| • 1/4" air hose nipple for 8 mm ID hose | 615 704 019 0 |
| • Clamping lever | 615 595 202 0 |
| • Complete dust extraction kit for version (-14) | 615 399 471 0 |

Pads :

| | For velcro-backed abrasive | For drilled velcro-backed abrasive (-8) or (-14) |
|---|----------------------------|--|
| • Pad ø 110 mm (4-3/8") - SC2(P) All versions | 615 990 102 0 | - |
| • Pad ø 127 mm (5") - SC3(P) | 615 990 123 0 | 615 990 124 0 |
| • Pad ø 150 mm (6") - SC4(P) | 615 990 125 0 | 615 990 126 0 |

OPTIONAL ACCESSORIES

Pads :

| | For self-adhesive abrasive | For drilled self-adhesive abrasive (-8) or (-14) |
|---|----------------------------|--|
| • Pad ø 110 mm (4-3/8") - SC2(P) All versions | 615 990 101 0 | - |
| • Pad ø 127 mm (5") - SC3(P) | 615 990 111 0 | 615 990 110 0 |
| • Pad ø 150 mm (6") - SC4(P) | 615 990 119 0 | 615 990 118 0 |

SC..P

- Suspension bail

615 570 532 0

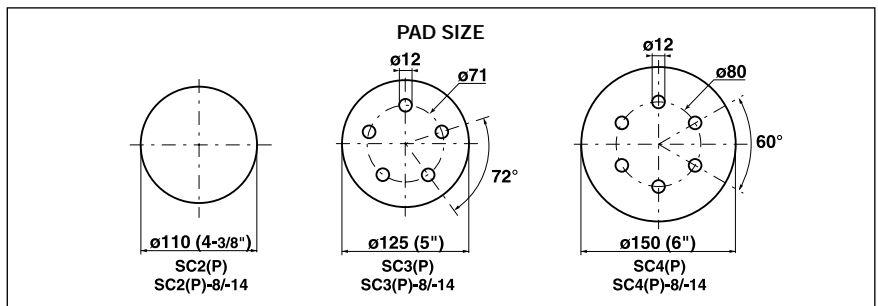

Random orbital sanders for abrasive discs

ø 110 mm (4-3/8") - ø 127 mm (5")
 - ø 150 mm (6")
 375 Watts (0.5 hp) - 10 000 rpm



SC4



SC4P



SC4-8



SC4P8



SC4P14

Caution: comply with the speeds recommended by component and abrasive manufacturers

| PAD | | MODEL | PART | MODEL | PART | MODEL | PART | WEIGHT | | AIR CONSUMPTION | | AIR | HOSE |
|---------------------------------|-------|--------------|-------------|----------------------|-------------|------------------|-------------|--------|------|-----------------|-------|------|------|
| SIZE | | | NUMBER | | NUMBER | | NUMBER | | | AT MAX OUTPUT | INLET | INT. | |
| mm | inch | | | | | | | kg | lb. | l/s | cfm | inch | Ø |
| SANDERS WITH PALM GRIP | | | | | | | | | | | | | |
| | | Suction-free | | With dust extraction | | Integral suction | | | | | | | |
| ø 110 | 4-3/8 | SC2 | 615 1700800 | SC2-8 | 615 1700920 | SC2-14 | 615 1700860 | 1.1 | 2.42 | 11 | 23 | 1/4 | 8 |
| ø 127 | 5 | SC3 | 615 1700820 | SC3-8 | 615 1700940 | SC3-14 | 615 1700880 | 1.2 | 2.64 | 11 | 23 | 1/4 | 8 |
| ø 150 | 6 | SC4 | 615 1700810 | SC4-8 | 615 1700930 | SC4-14 | 615 1700870 | 1.3 | 2.86 | 11 | 23 | 1/4 | 8 |
| SANDERS WITH HANDLE GRIP | | | | | | | | | | | | | |
| | | Suction-free | | With dust extraction | | Integral suction | | | | | | | |
| ø 110 | 4-3/8 | SC2P | 615 1700770 | SC2P8 | 615 1700890 | SC2P14 | 615 1700830 | 1.2 | 2.64 | 11 | 23 | 1/4 | 8 |
| ø 127 | 5 | SC3P | 615 1700790 | SC3P8 | 615 1700910 | SC3P14 | 615 1700850 | 1.3 | 2.86 | 11 | 23 | 1/4 | 8 |
| ø 150 | 6 | SC4P | 615 1700780 | SC4P8 | 615 1700900 | SC4P14 | 615 1700840 | 1.4 | 3.08 | 11 | 23 | 1/4 | 8 |

Accessories

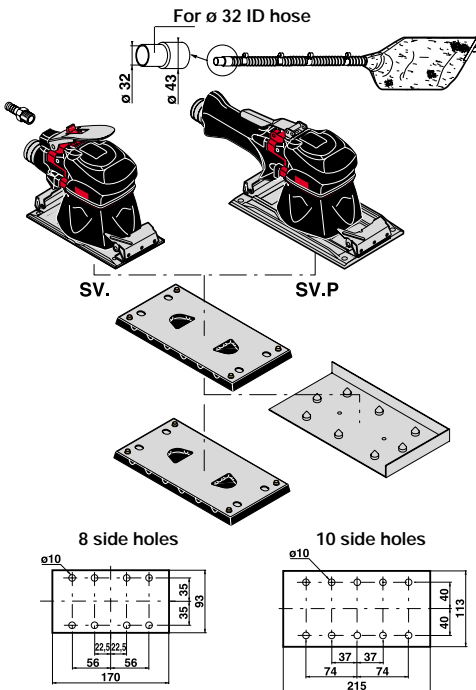
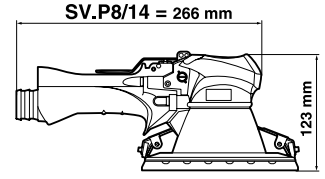
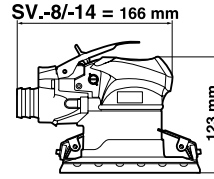
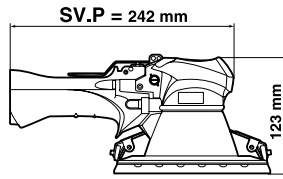
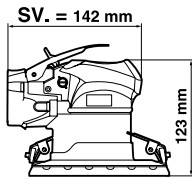

SV.. / SV..P

ACCESSORIES INCLUDED

| | PART NO. |
|--|---------------|
| • 1/4" air hose nipple for 8 mm ID hose | 615 704 019 0 |
| • Complete dust extraction kit for version (-14) | 615 399 471 0 |

| | Pad | Drilling plate for release (-8) or (-14) |
|----------------------------|---------------|--|
| • Pad 150 x 75 mm - SV2 | 615 350 017 0 | 615 990 093 0 |
| • Pad 170 x 93 mm - SV3(P) | 615 350 018 0 | 615 990 094 0 |
| • Pad 215 x 113 mm - SV4P | 615 350 019 0 | 615 990 095 0 |

OPTIONAL ACCESSORIES

| | PART NO. |
|---|---------------|
| • Pad 170 x 93 mm - 8 side holes SV3(P) | 615 350 057 0 |
| • Pad 215 x 113 mm - 10 side holes SV4P | 615 350 058 0 |

| | SV..P |
|-------------------|---------------|
| • Suspension bail | 615 570 532 0 |

SIZE OF SUPPLIED PADS

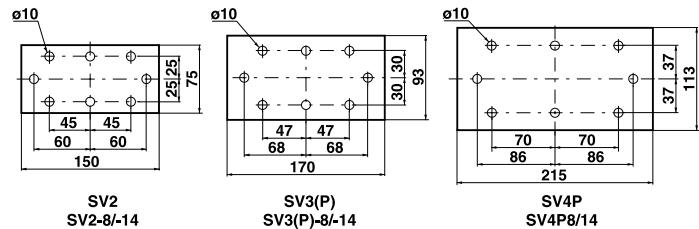

Orbital sanders for abrasive sheets

150 x 75 mm (6"x3")

170 x 93 mm (6-5/8"x3-5/8")

215 x 113 mm (8-1/2"x4-1/2")

375 Watts (0.5 hp) - 8 000 rpm



SV3



SV3P



SV3-8



SV3P8



SV3P14

Caution: comply with the speeds recommended by component and abrasive manufacturers

| PAD SIZE | | MODEL | PART NUMBER | MODEL | PART NUMBER | MODEL | PART NUMBER | WEIGHT | | AIR CONSUMPTION AT MAX OUTPUT | | AIR INLET THREAD | HOSE INT. Ø |
|----------|------|-------|-------------|-------|-------------|-------|-------------|--------|-----|-------------------------------|-----|------------------|-------------|
| mm | inch | | | | | | | kg | lb. | l/s | cfm | inch | mm |

SANDERS WITH PALM GRIP

| | | Suction-free | | With dust extraction | | Integral suction | | | | | | | |
|----------|---------------|--------------|-------------|----------------------|-------------|------------------|-------------|-----|------|----|----|-----|---|
| 150 x 75 | 6 x 3 | SV2 | 615 1700650 | SV2-8 | 615 1700730 | SV2-14 | 615 1700690 | 1.5 | 3.30 | 11 | 23 | 1/4 | 8 |
| 170 x 93 | 6-5/8 x 3-5/8 | SV3 | 615 1700660 | SV3-8 | 615 1700740 | SV3-14 | 615 1700700 | 1.7 | 3.74 | 11 | 23 | 1/4 | 8 |

SANDERS WITH HANDLE GRIP

| | | Suction-free | | With dust extraction | | Integral suction | | | | | | | |
|-----------|---------------|--------------|-------------|----------------------|-------------|------------------|-------------|-----|------|----|----|-----|---|
| 170 x 93 | 6-5/8 x 3-5/8 | SV3P | 615 1700670 | SV3P8 | 615 1700750 | SV3P14 | 615 1700710 | 1.8 | 3.96 | 11 | 23 | 1/4 | 8 |
| 215 x 113 | 8-1/2 x 4-1/2 | SV4P | 615 1700680 | SV4P8 | 615 1700760 | SV4P14 | 615 1700720 | 1.9 | 4.19 | 11 | 23 | 1/4 | 8 |

Accessories

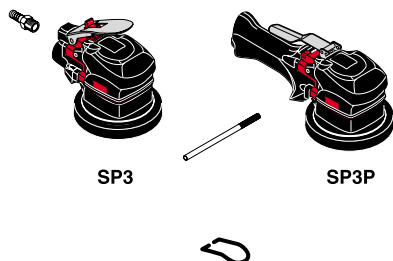
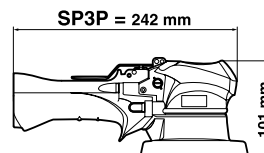
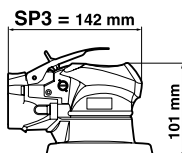

SP3 / SP3P

ACCESSORIES INCLUDED

- 1/4" air hose nipple for 8 mm ID hose
- Clamping lever

PART NO.

615 704 019 0
615 595 202 0

OPTIONAL ACCESSORIES

- Suspension bail

SP3P

615 570 532 0



Random orbital polishers with high offset \varnothing 127 mm (5")

375 Watts (0.5 hp) 10 000 rpm

Supplied with 5/16" F. tapped spindle only



SP3



SP3P

These polishers are balanced to be used with a velcro-backed pad \varnothing 127 mm (5"), thickness 16 mm (5/8"), weight 100 gr (0.22 lb), fitted with polishing foam, thickness 20 mm, weight 16 gr (0.03 lb).

Caution: comply with the speeds recommended by component and abrasive manufacturers

| PAD SIZE | | MODEL | PART NUMBER | WEIGHT | | CONSUMPTION AT MAX OUTPUT | | AIR INLET THREAD | HOSE INT. \varnothing |
|----------|------|-------|-------------|--------|----|---------------------------|-----|------------------|-------------------------|
| mm | inch | | | kg | lb | l/s | cfm | inch | mm |

POLISHER WITH PALM GRIP

| | | | | | | | | | |
|-------------------|---|--------------|---------------|-----|------|----|----|-----|---|
| | | Suction-free | | | | | | | |
| \varnothing 127 | 5 | SP3 | 615 170 198 0 | 1.2 | 2.64 | 11 | 23 | 1/4 | 8 |

POLISHER WITH HANDLE GRIP

| | | | | | | | | | |
|-------------------|---|--------------|---------------|-----|------|----|----|-----|---|
| | | Suction-free | | | | | | | |
| \varnothing 127 | 5 | SP3P | 615 170 197 0 | 1.3 | 2.86 | 11 | 23 | 1/4 | 8 |