

3129XP Mini Air Polisher Exploded View

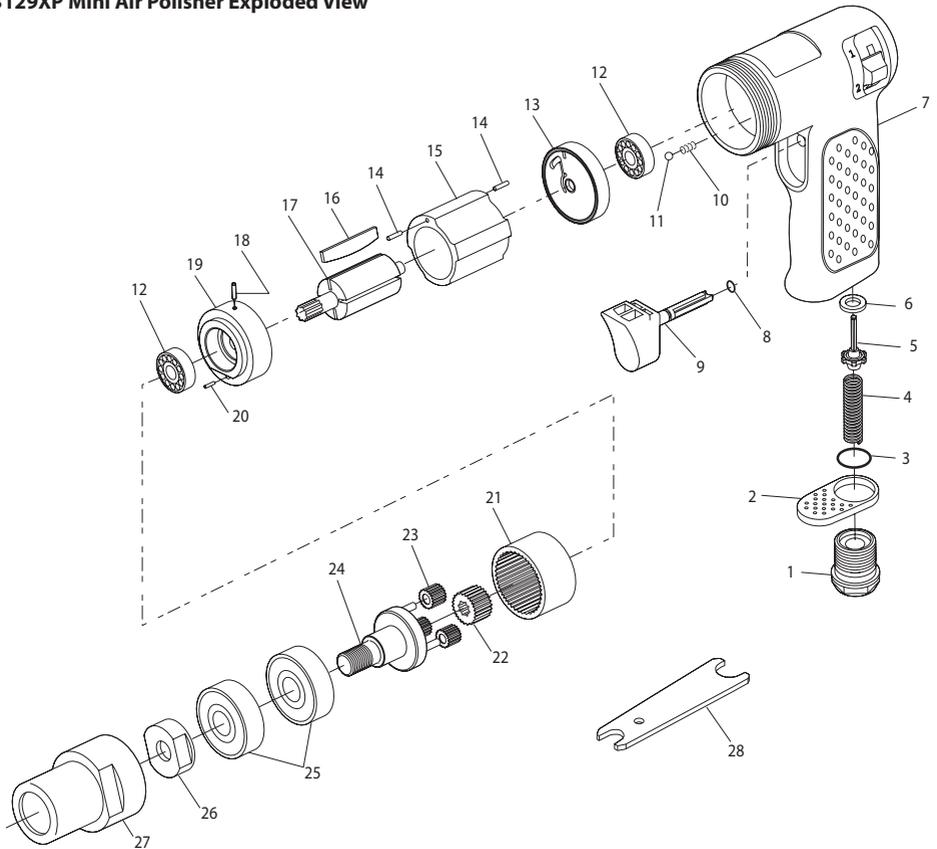

(Dwg. 16591547)

3129XP Mini Air Polisher Parts List

Item	Part Description	Part Number	Item	Part Description	Part Number
1	Inlet Bushing with Screen	3103-A465	16	Rotor Blade (4)	7804-42-4
2	Deflector	3103-23	17	Rotor	3129-53
3	O-Ring	3103-65	18	Roll Pin	3103-15
4	Valve Spring	3103-51	19	Front Plate	7804-11
5	Valve	3103-302	20	Pin	7804-15
6	Valve Seat	3103-303	21	Internal Gear	3129-9
7	Motor Housing Assembly	3129-A40	22	Pinion Gear	3129-9A
8	O-Ring	3103-65A	23	Idle Gear (3)	3129-9B-3
9	Trigger	3103-93	24	Work Spindle	3129-8
10	Spring	7804-250	25	Ball Bearing (2)	3129-97-2
11	Steel Ball	7804-722	26	Spindle Nut	3129-27
12	Ball Bearing (2)	3103-97-2	27	Lock Ring	7804-338
13	Rear Plate	3103-12	28	Spanner Wrench	3103-253
14	Roll Pin (2)	3103-120-2	*	Name Plate	3129-301
15	Cylinder	3103-3	*	Warning Label	3103-99

* Not Illustrated

Parts and Maintenance

When the life of the tool has expired, it is recommended that the tool be disassembled, degreased and parts be separated by material so that they can be recycled.

Tool repair and maintenance should only be carried out by an authorized Service Center.

Refer all communications to the nearest **Ingersoll Rand** Office or Distributor.

Related Documentation

For additional information refer to:

Product Safety Information Manual 04580387.

Product Information Manual 47132634.

Manuals can be downloaded from ingersollrandproducts.com