

OPERATION AND MAINTENANCE MANUAL FOR SERIES 88H HORIZONTAL AIR GRINDERS

NOTICE

Series 88H Grinders are designed for metal removal in foundry work and similar applications.

Ingersoll–Rand is not responsible for customer modification of tools for applications on which Ingersoll–Rand was not consulted.

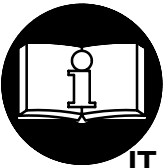

⚠ WARNING

**IMPORTANT SAFETY INFORMATION ENCLOSED.
READ THIS MANUAL BEFORE OPERATING TOOL.**

**IT IS THE RESPONSIBILITY OF THE EMPLOYER TO PLACE THE INFORMATION
IN THIS MANUAL INTO THE HANDS OF THE OPERATOR.**

FAILURE TO OBSERVE THE FOLLOWING WARNINGS COULD RESULT IN INJURY.

PLACING TOOL IN SERVICE

- Always operate, inspect and maintain this tool in accordance with American National Standards Institute Safety Code for Portable Air Tools (ANSI B186.1).
- For safety, top performance, and maximum durability of parts, operate this tool at 90 psig (6.2 bar/620 kPa) maximum air pressure at the inlet with 3/4" (19 mm) inside diameter air supply hose.
- Always turn off the air supply and disconnect the air supply hose before installing, removing or adjusting any accessory on this tool, or before performing any maintenance on this tool.
- Do not use damaged, frayed or deteriorated air hoses and fittings.
- Be sure all hoses and fittings are the correct size and are tightly secured. See Dwg. TPD905–1 for a typical piping arrangement.
- Always use clean, dry air at 90 psig maximum air pressure. Dust, corrosive fumes and/or excessive moisture can ruin the motor of an air tool.
- Do not lubricate tools with flammable or volatile liquids such as kerosene, diesel or jet fuel.
- Do not remove any labels. Replace any damaged label.

USING THE TOOL

- Always wear eye protection when operating or performing maintenance on this tool.
- Always wear hearing protection when operating this tool.
- Keep hands, loose clothing and long hair away from rotating end of tool.
- Anticipate and be alert for sudden changes in motion during start up and operation of any power tool.
- Keep body stance balanced and firm. Do not overreach when operating this tool. High reaction torques can occur at or below the recommended air pressure.
- Tool accessories may continue to rotate briefly after throttle is released.
- Air powered tools can vibrate in use. Vibration, repetitive motions or uncomfortable positions may be harmful to your hands and arms. Stop using any tool if discomfort, tingling feeling or pain occurs. Seek medical advice before resuming use.
- Use accessories recommended by Ingersoll–Rand.
- This tool is not designed for working in explosive atmospheres.
- This tool is not insulated against electric shock.

NOTICE

The use of other than genuine Ingersoll–Rand replacement parts may result in safety hazards, decreased tool performance, and increased maintenance, and may invalidate all warranties.

Repairs should be made only by authorized trained personnel. Consult your nearest Ingersoll–Rand Authorized Servicenter.

Refer All Communications to the Nearest
Ingersoll–Rand Office or Distributor.

© Ingersoll–Rand Company 2000

Printed in U.S.A.



WARNING LABEL IDENTIFICATION

⚠ WARNING

FAILURE TO OBSERVE THE FOLLOWING WARNINGS COULD RESULT IN INJURY.

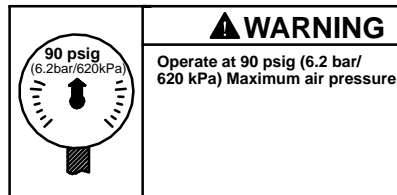
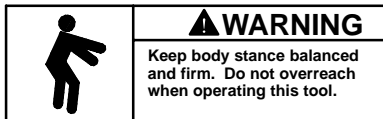
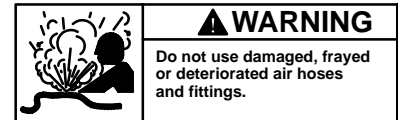
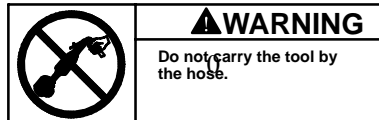
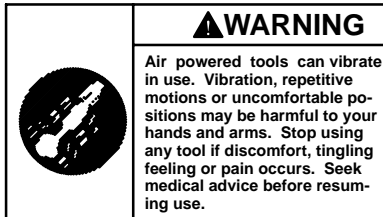
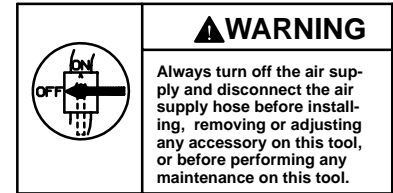
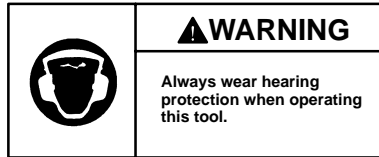
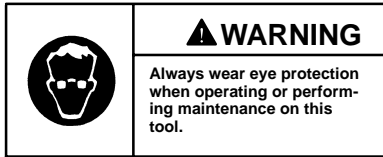

GRINDER SPECIFIC WARNINGS

- Do not use this tool if the actual free speed exceeds the nameplate rpm.
- Before mounting a wheel, after all tool repairs and whenever a Grinder is issued for use, check the free speed of the Grinder with a tachometer to make certain its actual speed at 90 psig (6.2 bar/620 kPa) does not exceed the rpm stamped or printed on the nameplate. Grinders in use on the job must be similarly checked at least once each shift.
- Always use the Ingersoll-Rand Wheel Guard furnished with the Grinder.
- Do not use a Grinder without the recommended wheel guard. Do not use any wheel for which the operating speed listed on the blotter is lower than the actual free speed of the Grinder.
- Inspect all grinding wheels for chips or cracks prior to mounting. Do not use a wheel that is chipped or cracked or otherwise damaged. Do not use a wheel that has been soaked in water or any other liquid.
- Make certain the grinding wheel properly fits the arbor. The wheel should not fit too snugly or too loosely. Plain hole wheels should have about 0.007" (0.17 mm) maximum diametral clearance. Do not use reducing bushings to adapt a wheel to any arbor unless such bushings are supplied by or recommended by the wheel manufacturer.
- After mounting a new wheel, hold the Grinder under a steel workbench or inside a casting and run it for at least 60 seconds. Make certain no one is within the operating plane of the grinding wheel. If the wheel is defective, improperly mounted or the wrong size and speed, this is the time it will usually fail.
- When starting a cold wheel, apply it to the work slowly until the wheel gradually warms up. Make smooth contact with the work, and avoid any bumping action or excessive pressure.
- Always replace a damaged, bent or severely worn wheel guard. Do not use a wheel guard that has been subjected to a wheel failure.
- Make certain the wheel flanges are at least 1/3 the diameter of the grinding wheel, free of nicks and burrs and sharp edges. Always use the wheel flanges furnished by the manufacturer; never use a makeshift flange or a plain washer.
- Guard opening must face away from operator. Bottom of wheel must not project beyond guard.
- Always use a wheel blotter between each wheel flange and the wheel. The blotters must be at least as large in diameter as the wheel flanges.
- Do not attempt to disassemble the Controller. The Controller is available only as a unit and is guaranteed for the life of the tool if it is not abused.
- Before installing a new Arbor Housing, select the correct Nameplate from the Nameplate Kit and secure it to the Arbor Housing with the Nameplate Screws.

GRINDER SPECIFIC WARNINGS

WARNING: Incorrect combinations of grinding wheel, wheel guard and tool speed could result in injury. Correct combinations are specified below:

Guard Part Number	Wheel Type	Wheel Diameter in. (mm)	Maximum Wheel Thickness in. (mm)	Maximum Speed rpm
88H60-961A	1	6(152)	1(25.4)	6,000

PLACING TOOL IN SERVICE

LUBRICATION



Ingersoll-Rand No. 50 Ingersoll-Rand No. 28

Always use an air line lubricator with these tools.
We recommend the following Filter-Lubricator-Regulator Unit:

For USA – No. C31-06-G00

Where lubricators cannot be permanently mounted, we recommend using an Ingersoll-Rand No. 8LUB12 Lubricator.

Before starting the tool, unless an air line lubricator is used, detach the air hose and inject about 1.5 cc of Ingersoll-Rand No. 50 Oil into the air inlet. Remove the Oil Chamber Plug and fill the chamber.

After each 8 hours of operation, or as experience indicates, remove the Oil Chamber Plug and fill the chamber.

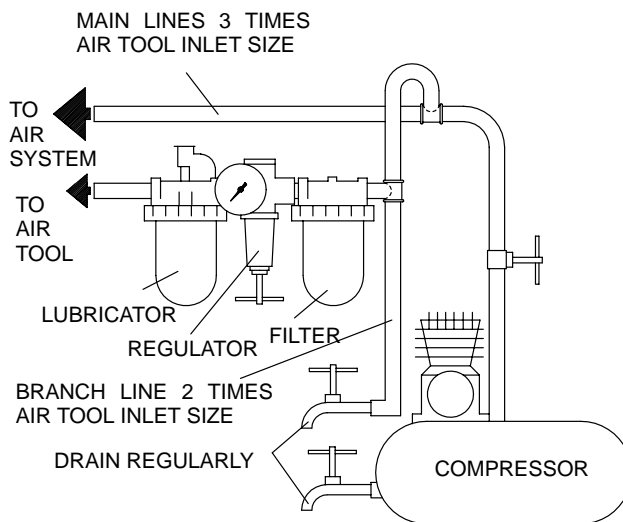

(Dwg. TPD905-1)

HOW TO ORDER A GRINDER

HORIZONTAL GRINDER with LEVER THROTTLE

Model	Free Speed rpm	Wheel	Spindle
88HL90L10	9,000	Cone	5/8"-11

HORIZONTAL GRINDER with LEVER THROTTLE

Model	Free Speed rpm	Type 1 Wheel		Spindle	Guard
		inches	mm		
88HL60H106	6,000	6	152	5/8"-11	6"

HORIZONTAL GRINDER with GRIP HANDLE

88HG60H106	6,000	6	152	5/8"-11	6"
------------	-------	---	-----	---------	----

MANUEL D'EXPLOITATION ET D'ENTRETIEN DES MEULEUSES HORIZONTALES DE LA SÉRIE 88H

NOTE

Les meuleuses de la Série 88H sont destinées à l'enlèvement des métaux dans les fonderies ou les applications similaires.

Ingersoll-Rand ne peut être tenu responsable de la modification des outils par le client pour les adapter à des applications qui n'ont pas été approuvées par Ingersoll-Rand.

⚠ ATTENTION

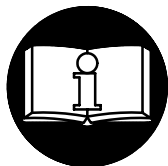

**D'IMPORTANTES INFORMATIONS DE SÉCURITÉ SONT JOINTES.
LIRE CE MANUEL AVANT D'UTILISER L'OUTIL.**

**L'EMPLOYEUR EST TENU DE COMMUNIQUER LES INFORMATIONS
DE CE MANUEL AUX EMPLOYÉS UTILISANT CET OUTIL.**

LE NON RESPECT DES AVERTISSEMENTS SUIVANTS PEUT CAUSER DES BLESSURES.

MISE EN SERVICE DE L'OUTIL

- Toujours exploiter, inspecter et entretenir cet outil conformément au Code de sécurité des outils pneumatiques portatifs de l'American National Standards Institute (ANSI B186.1).
- Pour la sécurité, les performances optimales et la durabilité maximale des pièces, cet outil doit être connecté à une alimentation d'air comprimé de 6,2 bar (620 kPa) maximum à l'entrée, avec un flexible de 19 mm de diamètre intérieur.
- Couper toujours l'alimentation d'air comprimé et débrancher le flexible d'alimentation avant d'installer, déposer ou ajuster tout accessoire sur cet outil, ou d'entreprendre une opération d'entretien quelconque sur l'outil.
- Ne pas utiliser des flexibles ou des raccords endommagés, effilochés ou détériorés.
- S'assurer que tous les flexibles et les raccords sont correctement dimensionnés et bien serrés. Voir Plan TPD905-1 pour un exemple type d'agencement des tuyauteries.
- Utiliser toujours de l'air sec et propre à une pression maximum de 6,2 bar. La poussière, les fumées corrosives et/ou une humidité excessive peuvent endommager le moteur d'un outil pneumatique.
- Ne jamais lubrifier les outils avec des liquides inflammables ou volatils tels que le kérosène, le gasoil ou le carburant d'aviation.
- Ne retirer aucune étiquette. Remplacer toute étiquette endommagée.

UTILISATION DE L'OUTIL

- Porter toujours des lunettes de protection pendant l'utilisation et l'entretien de cet outil.
- Porter toujours une protection acoustique pendant l'utilisation de cet outil.
- Tenir les mains, les vêtements fous et les cheveux longs, éloignés de l'extrémité rotative de l'outil.
- Prévoir, et ne pas oublier, que tout outil motorisé est susceptible d'à-coups brusques lors de sa mise en marche et pendant son utilisation.
- Garder une position équilibrée et ferme. Ne pas se pencher trop en avant pendant l'utilisation de cet outil. Des couples de réaction élevés peuvent se produire à, ou en dessous, de la pression d'air recommandée.
- La rotation des accessoires de l'outil peut continuer pendant un certain temps après le relâchement de la gâchette.
- Les outils pneumatiques peuvent vibrer pendant l'exploitation. Les vibrations, les mouvements répétitifs et les positions inconfortables peuvent causer des douleurs dans les mains et les bras. N'utiliser plus d'outils en cas d'inconfort, de picotements ou de douleurs. Consulter un médecin avant de recommencer à utiliser l'outil.
- Utiliser les accessoires recommandés par Ingersoll-Rand.
- Cet outil n'est pas conçu pour fonctionner dans des atmosphères explosives.
- Cet outil n'est pas isolé contre les chocs électriques.

NOTE

L'utilisation de rechanges autres que les pièces d'origine Ingersoll-Rand peut causer des risques d'insécurité, réduire les performances de l'outil et augmenter l'entretien, et peut annuler toutes les garanties.

Les réparations ne doivent être effectuées que par des réparateurs qualifiés autorisés. Consultez votre Centre de Service Ingersoll-Rand le plus proche.

Adressez toutes vos communications au Bureau Ingersoll-Rand ou distributeur le plus proche.

© Ingersoll-Rand Company 2000

Imprimé aux É.U.

To Buy Ingersoll Rand Products Online visit AirToolPro.com

Brought to you by Zampini Industrial Group - Factory Authorized Distribution Since 1987 - 1-800-353-4676



SIGNIFICATION DES ÉTIQUETTES D'AVERTISSEMENT

ATTENTION

LE NON RESPECT DES AVERTISSEMENTS SUIVANTS PEUT CAUSER DES BLESSURES.

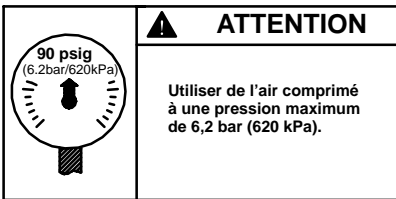
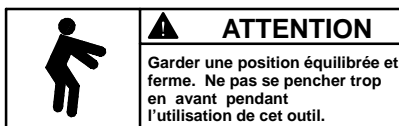
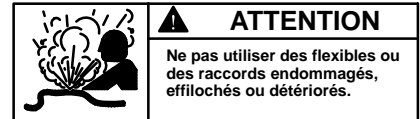
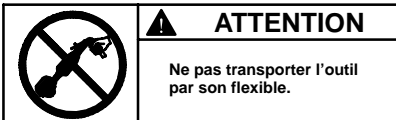
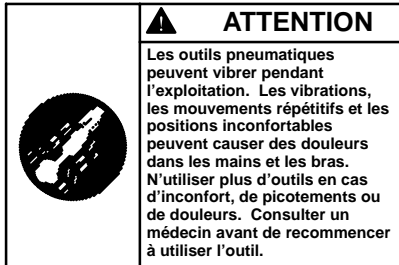
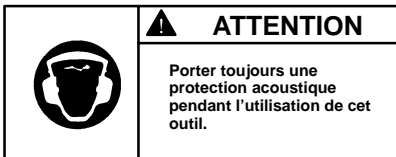
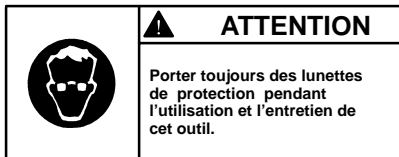

AVERTISSEMENTS SPÉCIFIQUES AUX MEULEUSES

- Ne pas utiliser cet outil si la vitesse à vide réelle dépasse celle indiquée sur la plaque signalétique.
- Avant de monter une meule, après toute réparation de l'outil ou avant de fournir une meuleuse pour utilisation, vérifier la vitesse à vide de la meuleuse avec un tachymètre pour s'assurer que la vitesse réelle à 6,2 bar (620 kPa) ne dépasse pas celle poinçonnée ou imprimée sur la plaque signalétique. Les meuleuses sorties sur chantier doivent être vérifiées de la même façon au moins une fois par poste.
- Utiliser toujours le protège-meule Ingersoll-Rand fourni avec la meuleuse.
- Ne jamais utiliser une meuleuse sans son protège-meule recommandé. Ne jamais utiliser de meule dont la vitesse de fonctionnement imprimée sur l'étiquette est inférieure à la vitesse à vide de meuleuse.
- Inspecter toutes les meules avant de les monter pour vérifier qu'elles ne présentent pas d'éclats ou de fissures. Ne jamais utiliser une meule écaillée, fissurée ou ayant un endommagement quelconque. Ne jamais utiliser une meule qui a été trempée dans l'eau ou tout autre liquide.
- S'assurer que la meule se monte correctement sur l'arbre. Le montage de la meule ne doit être ni serré ni libre. Les meules à trou lisse doivent présenter un jeu diamétral maximum de 0,17 mm. Ne pas utiliser de bagues réductrices, à moins que ces bagues soient recommandées et fournies par le fabricant de la meule.
- Après avoir monté une nouvelle meule, tenir la meuleuse sous un établi en acier ou dans une pièce coulée et la faire tourner pendant au moins 60 secondes. S'assurer que personne ne se tient dans le plan de rotation de la meule. Toute meule défectueuse, mal montée ou de dimension et vitesse incorrectes se cassera généralement à ce moment là.
- Pour commencer le travail avec une meule froide, l'appliquer lentement contre la pièce jusqu'à ce que la meule s'échauffe progressivement. Mettre la meule en contact avec la pièce en douceur en évitant tout choc ou pression excessive.
- Remplacer toujours un protège-meule endommagé, tordu ou très usé. Ne pas utiliser un protège-meule qui a été soumis à la rupture d'une meule.
- S'assurer que les flasques de meule couvrent au moins 1/3 du diamètre de la meule, et qu'ils sont exempts d'entailles, de bavures et d'arêtes vives. Utiliser toujours les flasques fournis par le fabricant ; ne jamais utiliser de flasque de provenance douteuse ou de rondelle plate.
- L'ouverture du protège-meule doit être orientée côté opposé à l'opérateur. Le bas de la meule ne doit pas dépasser le protège-meule.
- Monter toujours un disque en buvard entre les flasques et la meule. Les disques doivent avoir un diamètre au moins égal à celui des flasques.
- Ne jamais essayer de démonter le contrôleur. Ce dernier est fourni seulement comme un ensemble et est garanti pendant toute la durée de vie de l'outil s'il est utilisé correctement.
- Avant de monter un nouveau corps d'arbre, sélectionner la plaque signalétique correcte dans le kit de plaques et la fixer sur le corps d'arbre à l'aide des vis de plaque signalétique.

AVERTISSEMENTS SPÉCIFIQUES AUX MEULEUSES

ATTENTION: Une mauvaise combinaison de roue d'affûtage, de protection de roue et de vitesse de l'outil peut provoquer un accident corporel. Les combinaisons correctes sont spécifiées ci-dessous:

Référence de la protection	Type de roue	Diamètre de roue pouces (mm)	Épaisseur maximale de roue pouces (mm)	Vitesse maximale (t/min)
88H60-961A	1	6(152)	1(25,4)	6.000

MISE EN SERVICE DE L'OUTIL

LUBRIFICATION



Ingersoll-Rand No. 50 Ingersoll-Rand No. 28

Utiliser toujours un lubrificateur avec ces outils. Nous recommandons l'emploi du filtre-régulateur-lubrificateur suivant :

É.U. – No. C31-06-G00

Lorsque des lubrificateurs ne peuvent pas être installés de façon permanente, utiliser un lubrificateur Ingersoll-Rand No. 8LUB12.

Avant de mettre l'outil en marche, si un lubrificateur de ligne n'est pas utilisé, débrancher le flexible d'alimentation et verser environ 1,5 cm³ d'huile Ingersoll-Rand No. 50 dans le raccord d'admission de l'outil. Déposer le bouchon de l'huileur et remplir la chambre d'huile.

Toutes les huit heures de fonctionnement, ou en fonction de l'expérience, déposer le bouchon de la chambre d'huile et remplir cette dernière avec de l'huile.

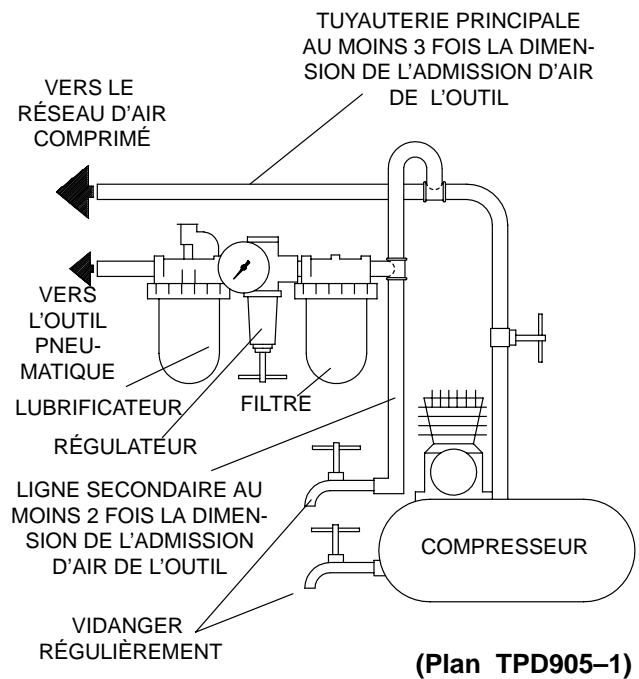

SPÉCIFICATIONS

Modèle	Poignée	Vitesse à vide tr/mn	Meule		Arbre
88HL90L10	à levier	9.000	cône		5/8" – 11
Modèle	Poignée	Vitesse à vide tr/mn	Meule Plate Ø		Arbre etprotege-meule
			pouces	mm	
88HL60H106	à levier	6.000	6	152	5/8"-11, 6"
88HG60H106	poignée fermée	6.000	6	152	5/8"-11, 6"

MANUAL DE FUNCIONAMIENTO Y MANTENIMIENTO PARA AMOLADORAS NEUMÁTICAS HORIZONTALES DE LA SERIE 88H

E

NOTA

Las amoladoras de la serie 88H–EU están diseñadas para eliminación de metal en trabajos de fundición y aplicaciones similares.

Ingersoll–Rand no aceptará responsabilidad alguna por la modificación de las herramientas efectuada por el cliente para las aplicaciones que no hayan sido consultadas con Ingersoll–Rand.

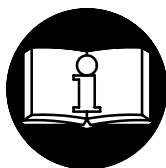

AVISO

SE ADJUNTA INFORMACIÓN IMPORTANTE DE SEGURIDAD. LEA ESTE MANUAL ANTES DE UTILIZAR LA HERRAMIENTA.

ES RESPONSABILIDAD DE LA EMPRESA ASEGURARSE DE QUE EL OPERARIO ESTÉ AL TANTO DE LA INFORMACIÓN QUE CONTIENE ESTE MANUAL.

EL HACER CASO OMISO DE LOS AVISOS SIGUIENTES PODRÍA OCASIONAR LESIONES.

PARA PONER LA HERRAMIENTA EN SERVICIO

- Utilice, inspeccione y mantenga esta herramienta siempre de acuerdo con todas las normativas locales y nacionales que se apliquen a las herramientas neumáticas de utilización manual o que se sujeten con la mano.
- Para mayor seguridad, rendimiento óptimo y larga vida útil de las piezas, utilice esta herramienta a una presión de aire máxima de 90 psig (6,2 bar/620 kPa) con una manguera de suministro de aire con diámetro interno de 19 mm.
- Corte siempre el suministro de aire y desconecte la manguera de suministro de aire antes de instalar, desmontar o ajustar cualquier accesorio de esta herramienta, o antes de realizar cualquier operación de mantenimiento de la misma.
- No utilice mangueras de aire y racores dañados, desgastados o deteriorados.
- Asegúrese de que todos los racores y mangueras sean del tamaño correcto y estén bien apretados. El Esq. TPD905–1 muestra una disposición característica de las tuberías.
- Use siempre aire limpio y seco a una presión máxima de 90 psig (6,2 bar/620 kPa). El polvo, los gases corrosivos y el exceso de humedad pueden estropear el motor de una herramienta neumática.
- No lubrique las herramientas con líquidos inflamables o volátiles tales como queroseno, gasoil o combustible para motores a reacción.
- No saque ninguna etiqueta. Sustituya toda etiqueta dañada.

UTILIZACIÓN DE LA HERRAMIENTA

- Use siempre protección ocular cuando utilice esta herramienta o realice operaciones de mantenimiento en la misma.
- Use siempre protección para los oídos cuando utilice esta herramienta.
- Mantenga las manos, la ropa suelta y el cabello largo alejados del extremo giratorio de la herramienta.
- Anticipe y esté atento a los cambios repentinos en el movimiento durante la puesta en marcha y utilización de toda herramienta motorizada.
- Mantenga una postura del cuerpo equilibrada y firme. No estire demasiado los brazos al manejar la herramienta. Pueden darse elevados pares de reacción a la presión de aire recomendada, e incluso a presiones inferiores.
- Los accesorios de la herramienta podrían seguir girando brevemente después de haberse soltado la palanca de mando.
- Las herramientas neumáticas pueden vibrar durante el uso. La vibración, los movimientos repetitivos o las posiciones incómodas pueden dañarle los brazos y manos. En caso de incomodidad, sensación de hormigueo o dolor, deje de usar la herramienta. Consulte con el médico antes de volver a utilizarla.
- Utilice únicamente los accesorios Ingersoll–Rand recomendados.
- Esta herramienta no ha sido diseñada para trabajar en ambientes explosivos.
- Esta herramienta no está aislada contra descargas eléctricas.

NOTA

El uso de piezas de recambio que no sean las auténticas piezas Ingersoll–Rand puede poner en peligro la seguridad, reducir el rendimiento de la herramienta y aumentar los cuidados de mantenimiento necesarios, así como invalidar toda garantía.

Las reparaciones sólo se deben encomendar a personal debidamente cualificado y autorizado. Consulte con el centro de servicio autorizado Ingersoll–Rand más próximo.

Toda comunicación se deberá dirigir a la oficina o al distribuidor Ingersoll–Rand más próximo.

© Ingersoll–Rand Company 2000

Impreso en EE. UU.



To Buy Ingersoll Rand Products Online visit AirToolPro.com

Brought to you by Zampini Industrial Group - Factory Authorized Distribution Since 1987 - 1-800-353-4676

ETIQUETAS DE AVISO

⚠ AVISO

EL HACER CASO OMISO DE LOS AVISOS SIGUIENTES PODRÍA OCASIONAR LESIONES.

	<p>⚠ ADVERTENCIA</p> <p>Use siempre protección ocular cuando utilice esta herramienta o realice operaciones de mantenimiento en la misma.</p>
---	--

	<p>⚠ ADVERTENCIA</p> <p>Use siempre protección para los oídos cuando utilice esta herramienta.</p>
---	---

	<p>⚠ ADVERTENCIA</p> <p>Cortar siempre el suministro de aire y desconectar la manguera de suministro de aire antes de instalar, retirar o ajustar cualquier accesorio de esta herramienta, o antes de realizar cualquier operación de mantenimiento de la misma.</p>
---	---

	<p>⚠ ADVERTENCIA</p> <p>Las herramientas neumáticas pueden vibrar durante el uso. La vibración, los movimientos repetitivos o las posiciones incómodas podrían dañarle los brazos y las manos. En caso de incomodidad, sensación de hormigueo o dolor, dejar de usar la herramienta. Consultar al médico antes de volver a utilizarla.</p>
---	---

	<p>⚠ ADVERTENCIA</p> <p>No coger la herramienta por la manguera para levantarla.</p>
---	---

	<p>⚠ ADVERTENCIA</p> <p>No utilizar mangueras de aire y accesorios dañados, desgastados ni deteriorados.</p>
---	---

	<p>⚠ ADVERTENCIA</p> <p>Mantener una postura del cuerpo equilibrada y firme. No estirar demasiado los brazos al manejar la herramienta.</p>
---	--

	<p>⚠ ADVERTENCIA</p> <p>Manejar la herramienta a una presión de aire máxima de 90 psig (6,2 bar/620 kPa).</p>
---	--

AVISOS ESPECÍFICOS SOBRE LA AMOLADORA

- No use esta herramienta si la velocidad en vacío real excede la indicada en la placa de identificación.
- Antes de montar una muela, después de cualquier reparación de la herramienta o al poner en servicio una amoladora, compruebe con un tacómetro la velocidad en vacío de la amoladora para asegurarse de que su velocidad real a 90 psig (620 bar/6.2 kPa) no exceda la velocidad estampada o impresa en la placa de identificación. Las amoladoras que están en uso también se deberán revisar al menos una vez en cada turno de trabajo.
- Use siempre el cubremuela Ingersoll–Rand suministrado con la amoladora.
- No use una amoladora sin el cubremuela recomendado. No use ninguna muela cuya velocidad de funcionamiento, tal y como aparece en la arandela de sujeción de la muela, sea menor que la velocidad en vacío real de la amoladora.
- Inspeccione todas las muelas antes de su montaje por si presentaran muescas o grietas. No use una muela que presente muescas o grietas o cualquier otro daño. No utilice una muela que haya estado a remojo en agua o en cualquier otro líquido.
- Asegúrese de que la muela esté bien puesta en el husillo. La muela no debe estar ni muy floja ni muy apretada. Las muelas de orificio normal deberán tener una holgura diamétrica máxima de aproximadamente 0,007 pulg. (0,17 mm). No use casquillos reductores para adaptar una muela al husillo a menos que éstos hayan sido suministrados o recomendados por el fabricante de muelas.
- Después de montar una muela nueva, sujete la amoladora bajo un banco de acero o dentro de un molde de fundición y hágala funcionar durante 60 segundos como mínimo. Asegúrese de que no haya nadie en el entorno de operación de la muela. Si la muela es defectuosa, está mal montada o es del tamaño y velocidad incorrectas, normalmente fallará en este momento.
- Cuando ponga en marcha una muela fría, aplíquela lentamente al trabajo hasta que se caliente gradualmente. Aplique la muela a la pieza suavemente, y evite golpes o exceso de presión.
- Cambie siempre un cubremuela dañado, torcido o muy desgastado. No use un cubremuela que haya experimentado un fallo de muela.
- Asegúrese de que las bridas de la muela tengan un diámetro mínimo de 1/3 del diámetro de la muela y que estén libres de marcas, rebabas y bordes afilados. Use siempre las bridas de muela suministradas por el fabricante; no use nunca una brida casera o arandela normal.
- La apertura del cubremuela deberá estar orientada hacia el lado opuesto del operario. La parte inferior de la muela no deberá sobresalir del cubremuela.
- Use siempre un anillo de sujeción entre cada brida de muela y la muela. Los anillos de sujeción deberán tener un diámetro como mínimo igual al de bridas de muela.
- No trate de desmontar el regulador. Éste está disponible únicamente como conjunto y está garantizado para toda la vida útil de la herramienta, siempre que se utilice como es debido.
- Antes de instalar una la carcasa del eje nueva, seleccione la placa de identificación adecuada del juego de placas de identificación, y fíjela en la carcasa del eje con los tornillos para la placa de identificación.

AVISOS ESPECÍFICOS SOBRE LA AMOLADORA

AVISO: Combinaciones incorrectas de rueda de rectificación, protector de rueda y velocidad de herramienta puedan resultar en lesionamientos. Las combinaciones correctas se especifican a continuación:

Número de Pieza del Protector	Tipo de Rueda	Diámetro de Rueda in. (mm)	Grosor Máximo de Rueda in. (mm)	Velocidad Máxima (rpm)
88H60-961A	1	6(152)	1(25,4)	6.000

PARA PONER LA HERRAMIENTA EN SERVICIO

LUBRICACIÓN



Ingersoll-Rand N° 50



Ingersoll-Rand N° 28

Utilice siempre un lubricador de aire comprimido con estas herramientas. Recomendamos utilizar el siguiente conjunto de filtro-lubricador-regulador:

EE. UU. – No. C31-06-G00

Cuando no se puedan montar lubricadores de manera permanente, recomendamos la utilización de un lubricador Ingersoll-Rand N° 8LUB12.

Antes de poner la herramienta en marcha, a menos que se haya puesto lubricante de línea de aire, desconecte la manguera de aire e inyecte alrededor de 1,5 cc de aceite Ingersoll-Rand N° 50 en la admisión de aire. Saque el tapón de la cámara de aceite y llene la cámara.

Después de cada ocho horas de funcionamiento, o como indique la experiencia, saque el tapón de la cámara de aceite y llene dicha cámara.

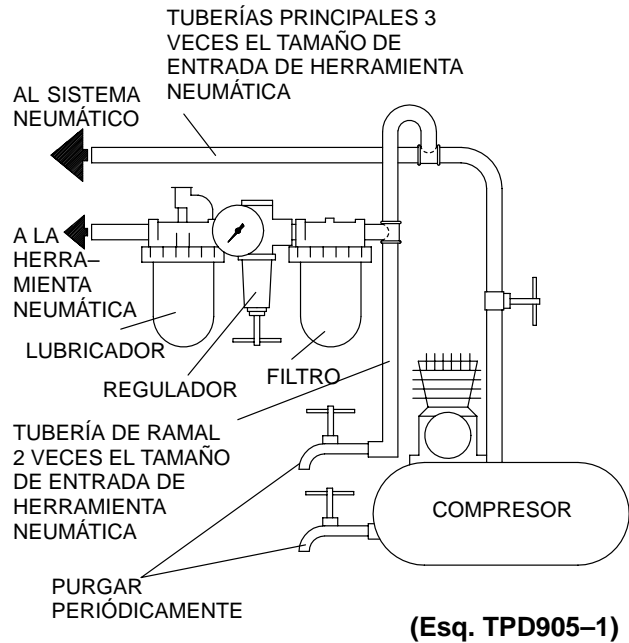

ESPECIFICACIONES

Modelo	Tipo de empuñadura	Velocidad en vacío	Muela		Husillo
		rpm			
88HL90L10	Palanca	9.000	Cono		5/8" – 11
Modelo	Tipo de empuñadura	Velocidad en vacío	Muela		Husillo y cubremuela
		rpm	pulg.	mm	
88HL60H106	Palanca	6.000	6	152	5/8" 11, 6"
88HG60H106	agarre	6.000	6	152	5/8"-11, 6"

MANUAL DE FUNCIONAMENTO E MANUTENÇÃO AS ESMERILADORAS PNEUMÁTICAS HORIZONTALS SÉRIES 88H

AVISO

As Esmeriladoras Séries 88H são concebidas para remoção de metais em trabalhos pesados em serviço de fundição e aplicações similares.

A Ingersoll-Rand não é responsável por modificações, feitas pelo cliente em ferramentas, nas quais a Ingersoll-Rand não tenha sido consultada.

⚠️ ADVERTÊNCIA

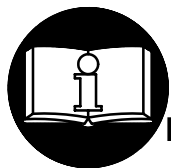

**INFORMAÇÃO DE SEGURANÇA IMPORTANTE EM ANEXO.
LEIA ESTE MANUAL ANTES DE OPERAR A FERRAMENTA.
É DA RESPONSABILIDADE DO EMPREGADOR COLOCAR A INFORMAÇÃO
DESTE MANUAL NAS MÃOS DO OPERADOR.
O NÃO CUMPRIMENTO DAS SEGUINTE ADVERTÊNCIAS PODE
RESULTAR EM FERIMENTOS.**

COLOCANDO A FERRAMENTA EM FUNCIONAMENTO

- Sempre opere, inspecione e mantenha esta ferramenta de acordo com o Código de Segurança do Instituto Americano de Padrões Nacionais para Ferramentas Pneumáticas Portáteis (ANSI B186.1).
- Para segurança, máximo desempenho e máxima durabilidade das peças, opere esta ferramenta com uma pressão de ar máxima de 6,2 bar/620 kPa (90 psig) na entrada da mangueira de alimentação de ar com diâmetro interno de 19 mm (3/4 pol.).
- Desligue sempre a alimentação de ar e desconecte a mangueira de alimentação de ar antes de instalar, remover ou ajustar qualquer acessório nesta ferramenta, ou antes de executar qualquer serviço de manutenção nesta ferramenta.
- Não use mangueiras de ar ou adaptadores danificados, gastos ou deteriorados.
- Certifique-se de que todas as mangueiras e adaptadores sejam do tamanho correcto e estejam apertados com firmeza. Veja o Desenho TPD905-1 para um arranjo típico de tubagem.
- Use sempre ar seco e limpo com pressão máxima de 90 psig. Pó, fumos corrosivos e/ou humidade excessiva podem arruinar o motor de uma ferramenta pneumática.
- Não lubrifique as ferramentas com líquidos inflamáveis ou voláteis tais como querosene, diesel ou combustível de jactos.

- Não remova nenhum rótulo. Reponha qualquer rótulo danificado.

USANDO A FERRAMENTA

- Use sempre óculos de protecção quando estiver operando ou executando serviço de manutenção nesta ferramenta.
- Use sempre protecção contra ruído ao operar esta ferramenta.
- Mantenha as mãos, partes do vestuário soltas e cabelos compridos afastados da extremidade em rotação.
- Antecipe e esteja alerta a mudanças repentinas no movimento quando ligar e operar qualquer ferramenta motorizada.
- Mantenha a posição do corpo equilibrada e firme. Não exagere quando operar esta ferramenta. Torques de reacção elevados podem ocorrer na ou abaixo da pressão de ar recomendada.
- Os acessórios da ferramenta podem continuar a girar brevemente após a pressão ter sido aliviada.
- Ferramentas accionadas pneumáticamente podem vibrar em uso. Vibração, movimentos repetitivos ou posições desconfortáveis podem ser prejudiciais às mãos e aos braços. Pare de usar a ferramenta caso ocorra algum desconforto, sensação de formigueiro ou dor. Procure assistência médica antes de retornar ao trabalho.
- Use acessórios recomendados pela Ingersoll-Rand.
- Esta Ferramenta não foi concebida para trabalhos em atmosferas explosivas.
- Esta Ferramenta não está isolada contra choques eléctricos.

AVISO

O uso de peças de substituição que não sejam genuinamente da Ingersoll-Rand podem resultar em riscos de segurança, diminuição do desempenho da ferramenta, aumento da necessidade de manutenção e pode invalidar todas as garantias.

As reparações devem ser feitas somente por pessoal treinado autorizado. Consulte o Centro de Serviços da Ingersoll-Rand mais próximo.

Envie Todos os Comunicados Para o Distribuidor ou Escritório da Ingersoll-Rand Mais Próximo.

© Ingersoll-Rand Company 2000

Impresso nos E.U.A.



To Buy Ingersoll Rand Products Online visit AirToolPro.com

Brought to you by Zampini Industrial Group - Factory Authorized Distribution Since 1987 - 1-800-353-4676

IDENTIFICAÇÃO DO RÓTULO DE ADVERTÊNCIA

▲ ADVERTÊNCIA

O NÃO CUMPRIMENTO DAS SEGUINTES ADVERTÊNCIAS PODE RESULTAR EM FERIMENTOS.

	▲ ADVERTÊNCIA Use sempre óculos de protecção quando estiver operando ou executando algum serviço de manutenção nesta ferramenta.
---	--

	▲ ADVERTÊNCIA Use sempre protecção contra o ruído ao operar esta ferramenta.
---	--

	▲ ADVERTÊNCIA Desligue sempre a alimentação de ar e desconecte a mangueira de alimentação de ar antes de instalar, remover ou ajustar qualquer acessório nesta ferramenta, ou antes de executar algum serviço de manutenção nesta ferramenta.
---	---

	▲ ADVERTÊNCIA Ferramentas accionadas pneumáticamente podem vibrar em uso. Vibração, movimentos repetitivos ou posições desconfortáveis podem ser prejudiciais às mãos e aos braços. Pare de usar a ferramenta caso ocorra algum desconforto, sensação de formigamento ou dor. Procure assistência médica antes de retornar ao trabalho.
---	---

	▲ ADVERTÊNCIA Não carregue a ferramenta segurando na mangueira.
---	---

	▲ ADVERTÊNCIA Não use mangueiras de ar ou adaptadores danificados, gastos ou deteriorados.
---	--

	▲ ADVERTÊNCIA Mantenha a posição do corpo equilibrada e firme. Não exagere quando operar esta ferramenta. Torques de reacção elevados podem ocorrer sob a pressão de ar recomendada.
---	--

	▲ ADVERTÊNCIA Opere com pressão do ar Máxima de 90–100 psig (6,2–6,9 bar).
---	--

ADVERTÊNCIAS ESPECÍFICAS SOBRE A ESMERILADORA

- Não use esta ferramenta se a velocidade livre total exceder a rpm indicada na placa de identificação.
- Antes de montar o disco, depois de qualquer reparação de ferramenta ou quando se pretende que uma Esmeriladora seja colocada em funcionamento, verifique a velocidade livre da Esmeriladora com um tacometro para se certificar de que a sua velocidade real a 6,2 bar/620kPa (90 psig) não exceda a rpm selada ou impressa na placa de identificação. As Esmeriladoras em funcionamento devem ser similarmente verificadas pelo menos uma vez em cada turno.
- Use sempre o Protector do Disco da Ingersoll–Rand fornecido com a Esmeriladora
- Não use uma Esmeriladora sem um resguardo do disco recomendado. Não use qualquer disco na qual a velocidade de operação indicada na chapa de características da máquina seja inferior à velocidade livre real da Esmeriladora.
- Certifique-se de que o disco se encaixa adequadamente na árvore de montagem. O disco não deve se adaptar muito apertado nem muito frouxo. Os discos do furo apenas devem ter uma folga diametral de no máximo 0.17 mm (0.007”). Não use rolamentos redutores para adaptar um disco na árvore de montagem a não ser que tais rolamentos tenham sido fornecidos ou recomendados pelo fabricante do disco.
- Depois de montar um novo disco, segure a Esmeriladora sob uma bancada de aço ou dentro de uma moldagem e coloque-a em funcionamento por 60 segundos. Verifique se não há ninguém dentro do plano de operação. Se o disco estiver com algum defeito, inadequadamente montado ou se for do tamanho errado ou tiver velocidade incorrecta, este é o momento em que ele normalmente falhará.
- Quando iniciar um trabalho com um disco frio, ponha-o a trabalhar lentamente até que o disco aqueça gradualmente. Faça um contacto suave com o local a ser trabalhado e evite de executar qualquer ação de batimento ou pressão excessiva.
- Reponha um protector do disco sempre que estiver danificado, torto ou severamente gasto. Não use um protector do disco que tenha sido sujeito a uma falha do disco.
- Certifique-se de que as flanges da roda sejam pelo menos 1/3 do diâmetro do disco de esmerilamento, livre de cortes, arestas e extremidades afiadas. Use sempre flanges do disco fornecidas pelo fabricante. Nunca use uma flange provisória ou uma anilha plana.
- A abertura do protector deve estar afastada do operador. O fundo do disco não deve se estender para fora do protector.
- Sempre use um adaptador de disco entre cada flange e o disco. Os adaptadores devem ser, pelo menos, tão grandes em diâmetro quanto as flanges dos discos.
- Não tente desmontar o Controlador. O Controlador é disponível apenas como uma unidade e é garantido pela vida útil da ferramenta se não houver abuso na sua utilização.
- Antes de instalar um Corpo de Árvore novo, seleccione a placa de identificação correcta da Lista de Itens fornecida e fixe-a no Corpo da Árvore com o Parafusos próprios.

ADVERTÊNCIAS ESPECÍFICAS SOBRE A ESMERILADORA

ADVERTÊNCIA: Combinações incorrectas de disco de esmerilamento, protector do disco e velocidade da ferramenta pode resultar em ferimento.

As combinações correctas estão especificadas abaixo:

Número de Peça do Protector	Tipo do Disco	Diâmetro do Disco	Espessura Máxima do Disco	Velocidade Máxima
		mm (pol.)	mm (pol.)	rpm
88H60-961A	1	152 (6)	25,4 (1)	6.000

COLOCANDO A FERRAMENTA EM FUNCIONAMENTO

LUBRIFICAÇÃO



Ingersoll-Rand No. 50 Ingersoll-Rand No. 28

E.U.A. - No. C31-06-G00

Quando lubrificadores não podem ser permanentemente montados, nós recomendamos o uso do Lubrificador Ingersoll-Rand No. 8LUB12.

Antes de colocar a ferramenta em funcionamento, a menos que se estiver usando um lubrificador de ar de linha, desligue a mangueira de ar e injecte cerca de 1,5 cc de Óleo Ingersoll-Rand No. 50 na entrada de ar. Remova o Bujão da Câmara de Óleo e encha a Câmara.

Depois de oito horas de operação, ou como a experiência indicar, remova o Bujão da Câmara de Óleo e encha a Câmara.

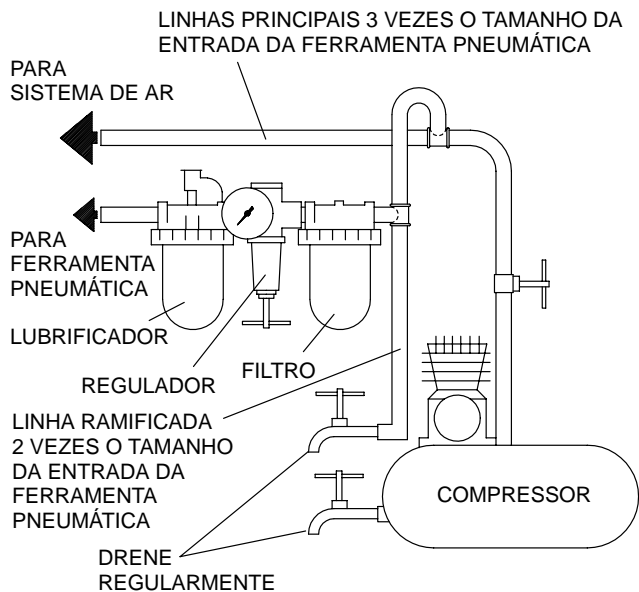

(Desenho TPD905-1)

ESPECIFICAÇÕES

Modelo	Tipo de Punho	Velocidade Livre	Disco		Veio
		rpm			
88HL90L10	alavanca	9.000	cônico		5/8" - 11
Modelo	Tipo de Punho	Velocidade Livre	Disco		Veio e Resguardo
		rpm	mm	pol.	
88HL60H106	alavanca	6.000	152	6	5/8"-11, 6"
88HG60H106	agarro	6.000	152	6	5/8"-11, 6"

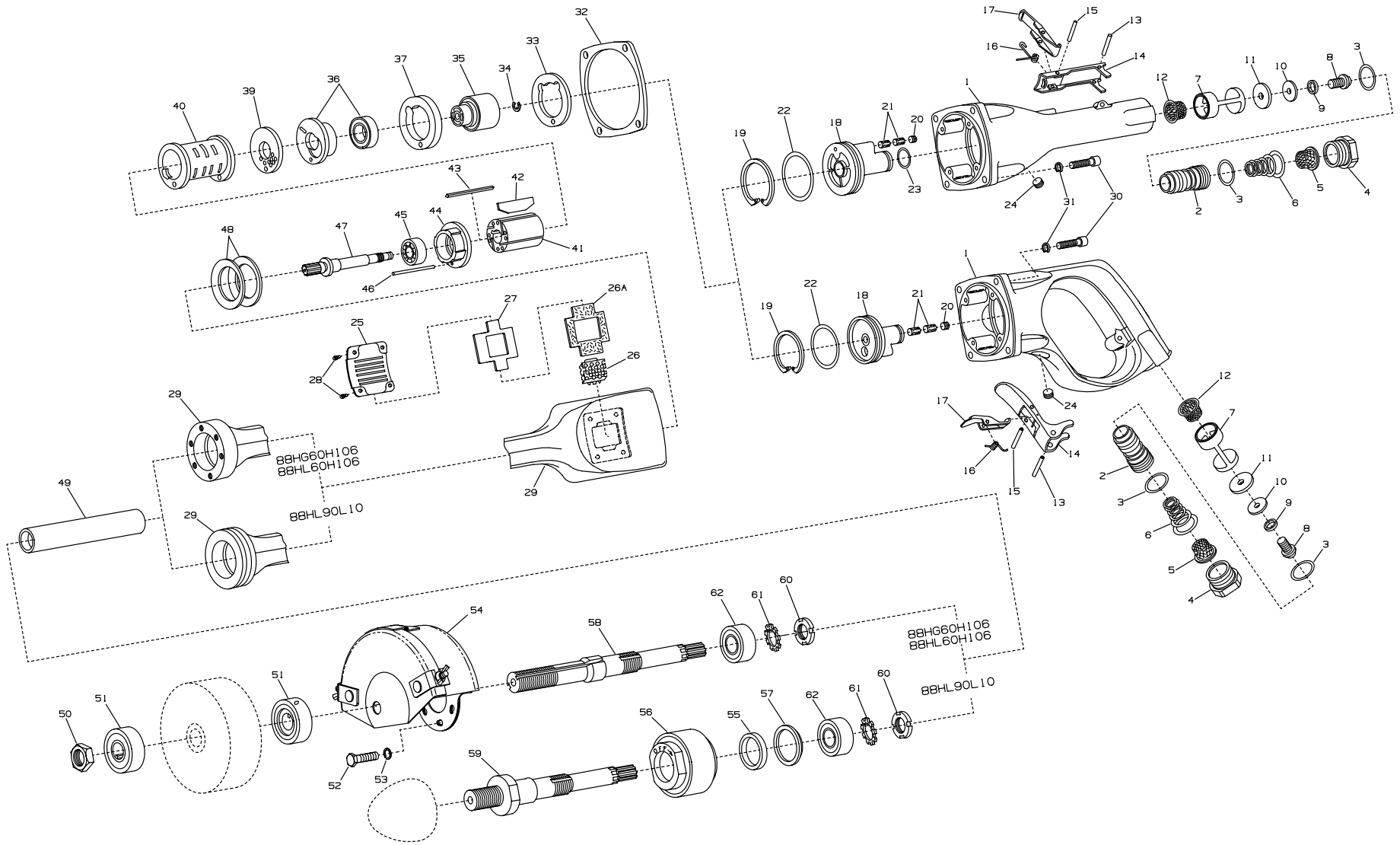

MAINTENANCE SECTION

(Dwg. TPA757-3)

PART NUMBER FOR ORDERING



		Grip Handle	Lever Handle
1	Throttle Handle Assembly	88HG60-A1	88HL60-A160
2	Throttle Valve Assembly	88V60-A302	88V60-A302
• 3	Seal (2)	C321-606	C321-606
4	Inlet Bushing	88V60-38	88V60-38
• 5	Inlet Bushing Screen	834-61	834-61
• 6	Throttle Valve Spring	99V60-262	99V60-262
7	Throttle Valve Seat Support Assembly	88V60-A303	88V60-A303
8	Valve Seat Screw	PS3-83	PS3-83
9	Valve Screw Lock Washer	H54U-352	H54U-352
10	Valve Seat Washer	99V60-155	99V60-155
• 11	Valve Seat	R4-159A	R4-159A
• 12	Air Strainer Screen	834-61	834-61
13	Throttle Lever Pin	MR-100	MR-100
14	Throttle Lever Assembly	88HG60-A400	88V60-A400
15	Lever Lock Pin	R100B-120	502B-120
16	Lever Lock Spring	88HG60-405	88V60-405
17	Lever Lock	88HG60-402	88V60-402
18	Oiler Body Assembly	88HG60-A198	88HL60-A198
19	Oiler Retainer	88HG60-298	88HL60-298
20	Oiler Adjusting Screw	R1-71A	R1-71A
21	Oiler Felt (2)	R1-75	R1-75
• 22	O-ring (Large)	M0V010AA-379	WFS182-210
• 23	O-ring (Small)	---	88HL60-103
24	Oil Chamber Plug	R2-227	R2-227

MAINTENANCE SECTION

• To keep downtime to a minimum, it is desirable to have on hand certain repair parts. We recommend that you stock one (pair or set) of each part indicated by a bullet (•) for every four tools in service.

PART NUMBER FOR ORDERING 

PART NUMBER FOR ORDERING 

25	Exhaust Deflector	88H60-23	34	Controller Retaining Ring	88V60-118
26	Exhaust Baffle	88H90-311	35	Controller Assembly (consists of Controller and Rotor Bearing Seal Assembly) for 88HG60H106 and 88HL60H106 (Blue)	88V60-A524
26A	Exhaust Deflector Gasket	88H60-129		for 88HL90L10 (Red)	88V85-A524
27	Exhaust Diffuser for 88HL60H106	99H80-123	36	Rotor Bearing Seal Assembly (consists of Rear Rotor Bearing and Rotor Bearing Seal)	88V60-A28
	for 88HL90L10	88H90-123			
28	Exhaust Deflector Screw (4)	99V60-200	37	Bearing Cage	88H60-107
+	Arbor Housing for 88HG60H106 and 88HL60H106	88H60-A40	39	Rear End Plate	88V60-12
	for 88HG60H106-EU and 88HL60H106-EU	88H60-EU-A40	40	Cylinder	88V60-3
	for 88H90L10	88H60-A40A	41	Rotor	88V60-53
	for 88H90L10-EU	88H60-EU-A40A	• 42	Vane Packet (set of 4 Vanes)	88V60-42-4
*	Nameplate Kit (for 88H60-EU-A40 and 88H60-EU-A40A)	88H-EU-K301	• 43	Rotor Key	88V60-70
*	Nameplate Screw (4) (for models ending in -EU)	C32-302	44	Front End Plate	88V60-11
*	Warning Label (for models ending in -EU)	EU-99	45	Front Rotor Bearing	R380-105
*	Nameplate Kit (for 88H60-A40 and 88H60-A40A)	88H-K301	• 46	Cylinder Dowel	88H60-98
*	Warning Label	WARNING-4-99	47	Rotor Shaft for 88HG60H106 and 88HL60H106 (13 teeth)	88H60-52
	Nameplate Screw (4)	C32-302		for 88HL90L10 (10 teeth)	88H90-52
30	Arbor Housing Screw (4)	88H60-29	48	Motor Clamp Washer (2)	88V60-207
31	Arbor Housing Lock Washer (4)	88H60-58	49	Arbor Coupling for 88HG60H106 and 88HL60H106 (13 teeth)	88H60-304
• 32	Arbor Housing Gasket	88H60-283		for 88HL90L10 (10 teeth)	88H90-304
• 33	Rear End Plate Gasket	88V60-739	50	Wheel Nut for 88HG60H106 and 88HL60H106 (5/8"-11 thread)	HU-776

MAINTENANCE SECTION

15

- * Not illustrated.
- To keep downtime to a minimum, it is desirable to have on hand certain repair parts. We recommend that you stock one (pair or set) of each part indicated by a bullet (•) for every four tools in service.
- + Whenever a new Arbor Housing Assembly is installed, select the correct Nameplate from the Nameplate Kit and attach it to the Housing with the Nameplate Screws.

PART NUMBER FOR ORDERING 

PART NUMBER FOR ORDERING 

51	Wheel Flange (2) (for 88HG60H106 and 88HL60H106)	88H60-16	• 61	Bearing Lock Washer	88H60-27
52	Guard Screw (6)	88H60-638	• 62	Arbor Bearing	G57E-24
53	Guard Screw Lock Washer (6)	88H60-67	*	Wheel Adapter Kit (for 88HG60H106) (consists of four Adapters for mounting Type 1 Wheels as follows:)	
54	Wheel Guard	88H60-961A		32 mm wide x 20 mm arbor hole;	
*	Guard Latch Screw for old style Guard with slotted dome Latch Retainer	88H60-7		32 mm wide x 32 mm arbor hole;	
	for new style Guard with smooth threaded face Latch Retainer	88H60-7A		25 mm wide x 20 mm arbor hole and 25 mm wide x 32 mm arbor hole	88H60-K900
55	Dust Washer	R4-35	*	Controller Wrench	88V60-950
56	Bearing Cap	88H-19	*	Seal Pressing Tool	99V60-951
57	Bearing Cap Spring	88H-20	*	Bearing Clamp	99V60-A952
58	Arbor (for Type 1 Grinding Wheels up to 1" wide) (for 88HG60H106 and 88HL60H106) (5/8"-11 thread) (13 teeth)	88H60-4-H10	*	Kit (includes 88V60-950, 99V60-951 and 99V60-A952)	88V60-K950
59	Cone Wheel Arbor (for 88HL90L10) (accommodates 3" Cone Wheel) (10 teeth)	88H90-104-L10	*	Cone Wheel Arbor Wrench	7RAQT4-254
60	Bearing Locknut	88H60-84	*	Deflector Screw Wrench	R2J-562
			*	Tune-up Kit (includes illustrated parts 3 [2], 5 [2], 6, 11, 12, 21 [2], 22, 23, 32, 33, 34 and 42)	88V/88H-TK3

- * Not illustrated.
- To keep downtime to a minimum, it is desirable to have on hand certain repair parts. We recommend that you stock one (pair or set) of each part indicated by a bullet (•) for every four tools in service.

MAINTENANCE SECTION

MAINTENANCE SECTION

WARNING

Always turn off the air supply and disconnect the air supply hose before installing, removing or adjusting any accessory on this tool, or before performing any maintenance on this tool. Failure to do so could result in injury.

LUBRICATION

Whenever a Series 88H Grinder is disassembled for overhaul or replacement of parts, lubricate as follows:

Inject about 1.5 cc of Ingersoll–Rand Pneu–Lube® Medium Lubricant No. 50 into the Inlet Bushing (4) after assembly. Fill the oil chamber. After each eight hours of operation, replenish the oil supply.

The use of an air line lubricator is recommended with these Grinders. Where the lubricator cannot be permanently mounted, we recommend using Ingersoll–Rand No. 8LUB12 Lubricator. For permanent installations, we recommend using Ingersoll–Rand No. C31–06–G00 Filter–Lubricator–Regulator Unit. These units have 3/4" pipe tap, 1/2 pt. (237 mL) capacity. Larger capacity units may be used, but do not use a unit having less than a 3/4" pipe tap inlet and outlet.

OILER ADJUSTMENT

The built–in lubricator has been properly adjusted at the factory. A lack of oil indicates the Oiler needs filling or the Oiler Felts are clogged and must be replaced as follows:

For Grip Handle Models

1. Remove the Arbor Housing Screws (30), Lock Washers (31) and Arbor Housing Gasket (32).
2. Remove the Oil Chamber Plug (24) and pour the oil from the oil chamber.
3. Using snap ring pliers remove the Oiler Retainer (19).
4. Insert a 1/4 x 20 (M6 x 1.0) machine screw in the pilot hole of the Oiler Body Assembly (18). See Dwg. TPD638.

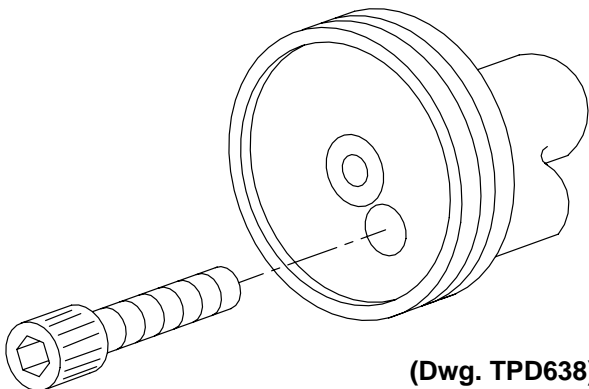

5. Grasping the screw head with pliers, pull out the Oiler Body Assembly (18).

6. With a thin–blade screwdriver, unscrew the Oiler Adjusting Screw (20).
7. Using tweezers or a piece of bent wire, remove the Oiler Felts (21) and install a new set.
8. Replace the Oiler Adjusting Screw, installing it slightly below flush.
9. Replenish the oil supply.

For Lever Handle Models

1. Remove the Arbor Housing Screws (30), Lock Washers (31) and Arbor Housing Gasket (32).
2. Remove the Oil Chamber Plug (24) and pour the oil from the oil chamber.
3. Using snap ring pliers, remove the Oiler Retainer (19).
4. Insert lock ring pliers in the hole of the Oiler Body Assembly (18) and pull out the Oiler Body Assembly.
5. With a thin–blade screwdriver, unscrew the Oiler Adjusting Screw (20).
6. Using tweezers or a piece of bent wire, remove the Oiler Felts and install a new set.
7. Replace the Oiler Adjusting Screw, installing it slightly below flush.
8. Replenish the oil supply.

DISASSEMBLY

General Instructions

1. Do not disassemble the tool any further than necessary to replace or repair damaged parts.
2. Whenever grasping a tool or part in a vise, always use leather–covered or copper–covered vise jaws to protect the surface of the part and help prevent distortion. This is particularly true of threaded members and housings.
3. Do not remove any part which is a press fit in or on a subassembly unless the removal of that part is necessary for repairs or replacement.
4. Do not disassemble the tool unless you have a complete set of new gaskets and O–rings for replacements.

Disassembly of the Arbor

1. Grasp the Arbor Housing (29) in a vise, guard upward.
2. **For Type 1 Wheels (Models 88HG60H106 and 88HL60H106)**, use an appropriate spanner wrench inserted into the pinhole of the flange to hold the Arbor. Unscrew the Wheel Nut (50) with an open–end wrench. Remove the Wheel Flanges (51).
3. Unscrew the Guard Screws (52). Remove the Guard Screw Lock Washers (53) and the Wheel Guard (54).
4. **For Cone Wheel (Model 88HL90L10)**, using an R3F–340 Cone Wheel Arbor Wrench to hold the Arbor, unscrew the cone wheel counterclockwise. Loosen and unscrew the Bearing Cap (56) from the Arbor Housing.
5. Unscrew the Bearing Cap from the Arbor Housing.

MAINTENANCE SECTION

6. Lift the Arbor (58) or (59) and the Arbor Coupling (49) from the Arbor Housing. Pull the Arbor Coupling off the Arbor.
7. Grasp the Arbor in a vise, spline end up.
8. With pliers, straighten the tangs of the Bearing Lock Washer (61). Unscrew the Bearing Locknut (60) and remove the Bearing Lock Washer.
9. If the Arbor Bearing (62) is to be replaced, press it from the arbor shaft.

Disassembly of the Motor and Throttle

1. Using the No. R2J-562 Deflector Screw Wrench, remove the Exhaust Deflector Screws (28) and lift off the Exhaust Deflector (25), Exhaust Deflector Gasket (26A), Exhaust Diffuser (27) in models where used and Exhaust Baffle (26).
2. Grasp the Arbor Housing (29) in a vise.
3. Unscrew the Arbor Housing Screws (30) and remove the Lock Washers (31).
4. Lift off the Throttle Handle Assembly (1) to expose the motor.
5. Remove the Arbor Housing Gasket (32).
6. Grasp the Controller Assembly (35) by hand and pull the motor unit out of the Arbor Housing (29).
7. Remove the Arbor Housing (29) from the vise. Turn over the Arbor Housing and the two Motor Clamp Washers (48) will drop out.
8. Grasp the Rotor Shaft (47) in the vise.
9. Remove the Controller Retaining Ring (34) and unscrew the Controller Assembly (35) which has a **left-hand thread**. This requires a clockwise rotation for removal.
10. If the Rear Rotor Bearing (36) needs to be replaced, insert the Rear Rotor Bearing into the 99V60-A952 Bearing Clamp and tighten the nut on the fixture. Insert the 99V60-951 Seal Pressing Tool in the center of the Rear Rotor Bearing and press off the Controller. Release the clamp.
11. Lift off the Rotor Bearing Seal (36), Bearing Cage (37) and Rear End Plate (39).
12. Lift off the Cylinder (40).
13. Remove the Vanes (42).

CAUTION

Use only the special 88V60-950 Controller Wrench for removing the Controller Assembly. Do not attempt to disassemble the Controller. It is available only as a unit and is guaranteed for the life of the tool if it is not abused.

14. Withdraw the Rotor (41) and lift out the Rotor Key (43).
15. Remove the rotor shaft and end plate assembly from the vise. Grasp the Front End Plate (44) in one hand and tap the small diameter end of the rotor shaft with a soft hammer to remove the end plate.
16. If the Front Rotor Bearing (45) is to be replaced, press it from the rotor shaft.
17. Unscrew the Oil Chamber Plug (24) from the Throttle Handle Assembly (1) and pour the oil from its reservoir.
18. Place the Throttle Handle Assembly (1) in a vise to remove the Inlet Bushing (4), Inlet Bushing Screen (5) and the Throttle Valve Spring (6). The Bushing has an interference thread and is tightly fit.
19. Drive out the Throttle Lever Pin (13) to release the Lever Assembly (14).
20. Release the Throttle Valve (2) by tapping the end of the handle with a soft hammer, or by using lock ring pliers.
21. Release the Throttle Valve Seat Support (7) by tapping the end of the handle with a soft hammer.
22. Remove the Valve Seat Screw (8), Valve Screw Lock Washer (9), Valve Seat Washer (10) and Valve Seat (11). The Air Strainer Screen (12) may now be cleaned.

ASSEMBLY

General Instructions

1. Always press on the **inner** ring of a ball-type bearing when installing the bearing on a shaft.
2. Always press on the **outer** ring of a ball-type bearing when pressing the bearing in a bearing recess.
3. Whenever grasping a tool or part in a vise, always use leather-covered or copper-covered vise jaws to protect the surface of the part and help prevent distortion. This is particularly true of threaded members and housings.
4. Always clean every part, and wipe every part with a thin film of oil before installation.

Assembly of the Throttle and Inlet

1. Assemble the Valve Seat Support Parts. Tighten the Valve Seat Screw (8) to 12 in-lb (1.4 Nm) torque.
2. Insert the Assembly in the handle, large diameter first. Locate a punch on the flat of the screw head and tap it with a hammer until the assembly is firmly seated.
3. Apply O-ring lubricant to the Seals (3). Fit the seals to the Throttle Valve (2) and push the assembly, small diameter first, into the handle until it seats firmly.
4. Assemble the Locking Lever Assembly (14) as illustrated in Dwgs. TPD563 and TPD646.

MAINTENANCE SECTION

For Lever Handle Models

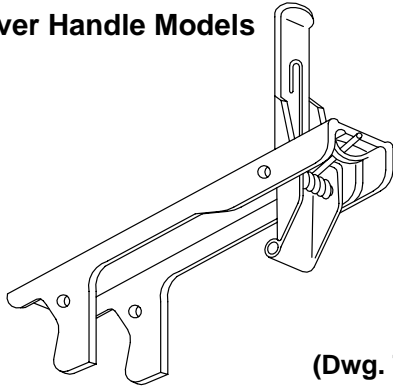

(Dwg. TPD563)

For Grip Handle Models

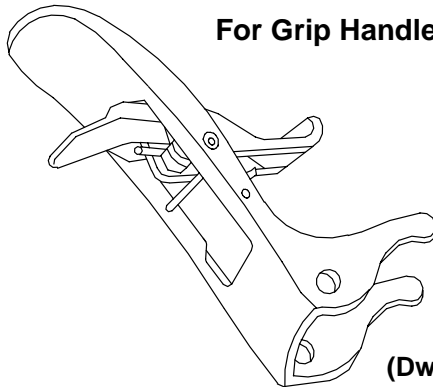

(Dwg. TPD646)

Locking Lever Assembly for 88H Grinders

5. Align the holes in the Lever Assembly (14) with the slots in the Throttle Handle. With a soft hammer, tap the Throttle Lever Pin (15) through the Lever Assembly. File off any sharp edges. Operate the mechanism internally by hand to assure operation.
6. Grasp the Throttle Handle in a vise.
7. Insert the Throttle Valve Spring (6) small end first.
8. Clean the face of the Inlet Bushing (4) and the Inlet Bushing Screen (5) with kerosene, blow dry with air before assembling into the tool. Insert the parts in the end of the Throttle Handle. With a Wrench tighten the Inlet Bushing (4) to 35 to 45 ft-lb (47–61 Nm) torque.

Assembly of the Motor

1. Using an arbor press, press against the inner race of the bearing to install the Front Rotor Bearing (45) onto the Rotor Shaft (47).
2. Inspect the Front End Plate (44) for nicks or burrs. Replace if necessary. Install the Front End Plate over the Rotor Shaft (47) and onto the Front Rotor Bearing (45). This is a light press fit.

3. Hold the Rotor Shaft in a vise. Insert the Rotor Key (43) in the slot of the Rotor (41). The Rotor has a staked keyway on one end. Place that end up, over the rotor shaft. Apply a light film of the recommended oil to each Vane (42) and insert one vane, straight edge out, into each slot in the Rotor. If any new vanes are required, replace the entire set.
4. Place the Cylinder (40) over the Rotor matching the Cylinder Dowel hole to the alignment hole in the Front End Plate (44), with the kidney port to the **right** of the dowel hole.
5. Apply the Rear End Plate (39) with the kidney port to the **right** of the dowel hole.

NOTICE

If the Controller Assembly (35) needs to be replaced, you must also replace the Rotor Bearing Seal Assembly (36) which consists of the Rear Rotor Bearing and Rotor Bearing Seal. If either the Rear Rotor Bearing or Rotor Bearing Seal needs to be replaced, **BOTH** must be replaced with a new Bearing and Seal. Do not mix old and new parts.

6. Check the outside diameter and large inside diameter of the Rotor Bearing Seal for wear. If the outside diameter of the hub is worn to 1.1764" or smaller, and/or the large inside diameter is worn to 0.9103" or larger, install a new Rotor Bearing Seal Assembly (36).

NOTICE

Take all measurements 30 degrees to the left of the dowel hole when facing the hub side of the Seal. Install the Rotor Bearing Seal.

7. Press the Rear Rotor Bearing onto the hub of the Controller.
8. Slip the Controller Assembly over the Rotor Shaft. Rotate the Controller counterclockwise since this is a left-hand thread.

CAUTION

Use only the special No. 88V60–950 Controller Wrench for applying the assembly.

WARNING

Tighten the Controller to 14 to 16 ft-lb (19.0 to 21.7 Nm) torque. **DO NOT EXCEED 16 ft-lb.** The Controller may be damaged if this torque is exceeded. Always check the free speed of a Grinder after it has been reassembled and before it is put back into service. Refer to Test Procedure on Page 21. **NEVER** use a Grinder which runs in excess of the maximum speed listed in the Test Procedure.

MAINTENANCE SECTION

9. Install the Controller Retaining Ring (34), **concave** face closest to the Controller.
10. Grasp the Throttle Handle Assembly (1) in a vise, wide end up with the Throttle Lever facing right.
11. Insert the assembled motor into the Throttle Handle Assembly (1) aligning the Cylinder Dowel (46) with the upper left-hand dowel pin hole.
12. Lightly dampen the Arbor Housing Gasket (32) with oil and align it with the holes in the Throttle Handle Assembly (1).
13. Insert the two Motor Clamp Washers (48) over the spline of the Rotor Shaft, concave side up so the inner rim contacts the Front End Plate (44).
14. Place the Arbor Housing (29) onto the Throttle Handle Assembly (1).

NOTICE

Make sure THE NOTCH on the face of the Arbor Housing lines up with the Cylinder Dowel of the motor. Exhaust will be to the right of the operator.

NOTICE

Rotating the housing and motor and aligning the Cylinder Dowel with each of the dowel pin holes changes the direction of exhaust 90 degrees.

15. Place Lock Washers on the Arbor Housing Screws (30) and slightly tighten opposite screws; then tighten all screws to 14 ft-lb (19 Nm) torque.
16. Install the Exhaust Baffle (26), Exhaust Diffuser (27) in models where used and the Exhaust Deflector (25) and Exhaust Deflector Gasket (26A) in the Arbor Housing. Insert the Exhaust Deflector Screws (28) and tighten with the No. R2J-562 Deflector Screw Wrench.

Assembly of the Arbor

1. **For Model 88HL90L10**, insert the Dust Washer (55) followed by the Bearing Cap Spring (57), concave side first, into the Bearing Cap (56). Slide the Bearing Cap followed by the Arbor Bearing onto the Arbor shaft from the rear.

2. Press the Arbor Bearing (62) onto the Arbor Shaft (58).
3. Grasp the Arbor Shaft in a vise, spline end up.
4. Install the Bearing Lock Washer (61) and Bearing Locknut (60). Tighten the Locknut snugly. Bend the tangs of the Bearing Lock Washer into the grooves of the Bearing Locknut.
5. Remove the Arbor Shaft from the vise.
6. Grasp the Arbor Housing (29) in a vise, Guard end up.
7. Coat the spline of the Rotor Shaft (47) and the spline of the Arbor Shaft (58) or (59) with 3 to 4 cc of Ingersoll-Rand No. 28 Grease. Insert the Arbor Coupling (49) into the Arbor Housing and onto the spline of the Rotor Shaft. Slip the spline of the Arbor Shaft into the Arbor Coupling.
8. **For Type 1 Wheels**, place the Wheel Guard (54) onto the Arbor Housing (29), making sure the holes are aligned. Install the Guard Screw Lock Washers (53) and Guard Screws (55). Tighten to 15 ft-lb (20.3 Nm) torque.
9. Install a Wheel Flange (51), Wheel and the other Wheel Flange (51) onto the Arbor (58).

NOTICE

Slip the flanges onto the arbor so the keys are opposite each other.

10. Using an applicable Spanner Wrench inserted into the pin hole of the flange to hold the arbor, install the Wheel Nut (51) with an open-end wrench. Only tighten sufficiently to drive the wheel and prevent slippage.
11. **For Cone Wheel (Model 88HL90L10)**, thread the Bearing Cap on the Arbor Housing and tighten to 40 to 45 ft-lb (54 to 61 Nm) torque.
12. Using a No. R3F-340 Cone Wheel Arbor Wrench to hold the Arbor (59), install the cone wheel turning clockwise until hand-tight.
13. Fill the oil chamber with the recommended oil and insert the Oil Chamber Plug (24). Tighten to 4 ft-lb (5.4 Nm) torque.

MAINTENANCE SECTION

TEST AND INSPECTION PROCEDURE

Run the performance tests at 90 psig (6.2 bar/620 kPa) air pressure at the inlet of the tool with an eight foot (2.44 m) length of 3/4" (19 mm) diameter air supply hose.

- Without a wheel on the tool, operate the Grinder with the Throttle Lever fully depressed and check the free speed by applying a hand-held tachometer to the spindle end. The minimum and maximum allowable free speeds are as follows:

Model	Stamped	Free Speed	
		Minimum	Maximum
88H60	6000	5650	6050
88H90	9000	7950	8550

- Test the Grinder motor for power to determine these **minimum** performance levels. The Throttle Lever must not be actuated repeatedly during the test. Depress the Lever and hold it in the open position until the test is complete.

Model	Torque		Speed, rpm (r/min)
	ft-lb	Nm	-at-
88H60	1.89	2.6	5000
88H90	1.60	2.2	6500

If a dynamometer is not available, test the Grinder using a properly calibrated test fan and fan cage combination to determine the following **minimum** speeds:

Model	Fan	Minimum Speed, rpm (r/min)
88H60	R3	4700
88H90	R2	5700

- There must be no objectionable leaks in any non-exhaust area. The Throttle must not leak when it is closed.
- There must be no leaks past the closed Throttle that will run the motor.
- The Grinder must start smoothly when the Throttle Lever is depressed and must shut off completely when the Throttle Lever is released.
- The Grinder must be equipped with a spring-loaded window style Lock (17). The Lock must return to the locked position when the Throttle Lever is released.
- The tool must run smoothly without noticeable vibration or unusual sound.



DISCONNECT THE GRINDER FROM THE AIR SUPPLY HOSE AND SHUT OFF AIR TO THE TOOL BEFORE PROCEEDING WITH THE TEST AND INSPECTION PROCEDURE.

- The Arbor (58 or 59) must turn freely with no evidence of brinelled bearings.
- The Threads on the arbor must be free of nicks and damage.
- The Nameplate must be legible, in place and securely fastened. Make replacement if necessary.

MAINTENANCE SECTION

TROUBLESHOOTING GUIDE

Trouble	Probable Cause	Solution
Low power or low free speed	Low air pressure at the Inlet	Check the air pressure at the Inlet. For maximum performance and durability of parts, the pressure must not exceed 90 psig (6.2 bar/620 kPa).
	Plugged Screens	Clean the Screens in a clean, suitable cleaning solution in a well ventilated area. If the screen cannot be cleaned, replace it. <div style="text-align: center;">⚠ WARNING</div> Never operate a Grinder without an inlet screen. Ingestion of dirt into the Grinder can, in some cases, cause an unsafe condition.
	Worn or broken Vanes	Replace a complete set of Vanes.
	Worn or broken Cylinder	Replace the Cylinder if it appears cracked or if the bore is wavy or scored.
	Improper lubrication or dirt build-up in the motor	Lubricate the Grinder as instructed in LUBRICATION . If lubrication does not result in satisfactory operation, disassemble the motor, inspect and clean all parts.
High free speed	Worn Rotor Bearing Seal	Replace the Rotor Bearing Seal Assembly if the outside diameter of the hub is worn to 1.1764" or smaller and/or the large inside diameter is worn to 0.9103" or larger.
Rough operation	Worn or broken Rear Rotor Bearing or Front Rotor Bearing	Examine each Bearing. Replace Rotor Bearing Seal Assembly or Front Rotor Bearing if worn or damaged.
	Worn Rotor Key	Replace the Key. Check the Rotor Shaft or Rotor for key slot wear and replace if necessary.
	Bent Arbor	Mount the Arbor on centers. Check the bearing diameter for runout with an indicator. Replace the Arbor if runout exceeds 0.002" (0.051 mm) Total Indicator Reading.
Scoring	Improper assembly	Make certain that all motor parts are properly aligned prior to clamping the motor assembly.
Air leaks	Worn Valve Seat or Valve Seat Washer	Replace worn parts.
	Worn Throttle Valve Seals	Replace both Seals.
	Worn Arbor Housing Gasket	Replace the Gasket.
	Oiler Plug worn or not tight	Tighten the Plug. If the problem persists, replace the Plug.

NOTICE

SAVE THESE INSTRUCTIONS. DO NOT DESTROY.

NOTES