

## OPERATION AND MAINTENANCE MANUAL FOR SERIES 99V VERTICAL AIR GRINDERS

### NOTICE

Series 99V Grinders are designed for smoothing, trimming or removing metal in foundries, shipyards, steel mills and in construction applications.

Ingersoll-Rand is not responsible for customer modification of tools for applications on which Ingersoll-Rand was not consulted.



### ⚠ WARNING

**IMPORTANT SAFETY INFORMATION ENCLOSED.  
READ THIS MANUAL BEFORE OPERATING TOOL.**

**IT IS THE RESPONSIBILITY OF THE EMPLOYER TO PLACE THE INFORMATION  
IN THIS MANUAL INTO THE HANDS OF THE OPERATOR.**

**FAILURE TO OBSERVE THE FOLLOWING WARNINGS COULD RESULT IN INJURY.**

#### PLACING TOOL IN SERVICE

- Always operate, inspect and maintain this tool in accordance with American National Standards Institute Safety Code for Portable Air Tools (ANSI B186.1).
- For safety, top performance, and maximum durability of parts, operate this tool at 90 psig (6.2 bar/620 kPa) maximum air pressure at the inlet with 3/4" (19 mm) inside diameter air supply hose.
- Always turn off the air supply and disconnect the air supply hose before installing, removing or adjusting any accessory on this tool, or before performing any maintenance on this tool.
- Do not use damaged, frayed or deteriorated air hoses and fittings.
- Be sure all hoses and fittings are the correct size and are tightly secured. See Dwg. TPD905-1 for a typical piping arrangement.
- Always use clean, dry air at 90 psig maximum air pressure. Dust, corrosive fumes and/or excessive moisture can ruin the motor of an air tool.
- Do not lubricate tools with flammable or volatile liquids such as kerosene, diesel or jet fuel.
- Do not remove any labels. Replace any damaged label.

#### USING THE TOOL

- Always wear eye protection when operating or performing maintenance on this tool.
- Always wear hearing protection when operating this tool.
- Keep hands, loose clothing and long hair away from rotating end of tool.
- Anticipate and be alert for sudden changes in motion during start up and operation of any power tool.
- Keep body stance balanced and firm. Do not overreach when operating this tool. High reaction torques can occur at or below the recommended air pressure.
- Tool accessories may continue to rotate briefly after throttle is released.
- Air powered tools can vibrate in use. Vibration, repetitive motions or uncomfortable positions may be harmful to your hands and arms. Stop using any tool if discomfort, tingling feeling or pain occurs. Seek medical advice before resuming use.
- Use accessories recommended by Ingersoll-Rand.
- This tool is not designed for working in explosive atmospheres.
- This tool is not insulated against electric shock.

### NOTICE

The use of other than genuine Ingersoll-Rand replacement parts may result in safety hazards, decreased tool performance, and increased maintenance, and may invalidate all warranties.

Repairs should be made only by authorized trained personnel. Consult your nearest Ingersoll-Rand Authorized Servicenter.

Refer All Communications to the Nearest  
Ingersoll-Rand Office or Distributor.

© Ingersoll-Rand Company 2000

Printed in U.S.A.



## WARNING LABEL IDENTIFICATION

### ⚠ WARNING

FAILURE TO OBSERVE THE FOLLOWING WARNINGS COULD RESULT IN INJURY.

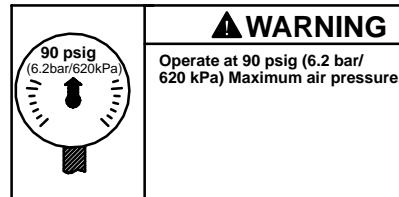
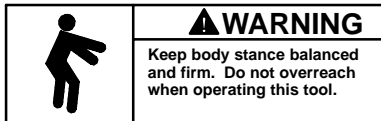
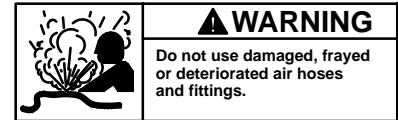
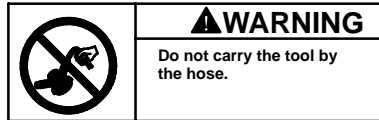
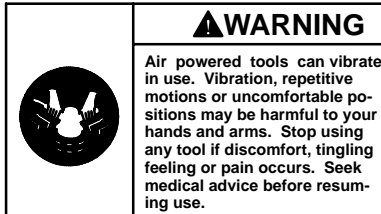
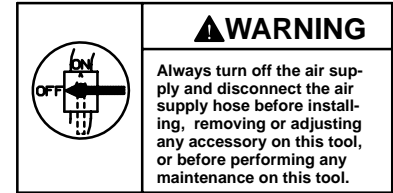
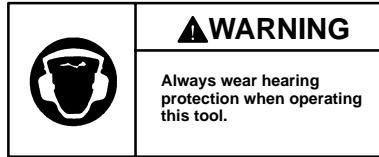
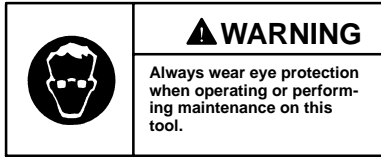

## GRINDER SPECIFIC WARNINGS

- Do not use this tool if the actual free speed exceeds the nameplate rpm.
- Before mounting a wheel, after all tool repairs and whenever a Grinder is issued for use, check the free speed of the Grinder with a tachometer to make certain its actual speed at 90 psig (6.2 bar/620 kPa) does not exceed the rpm stamped or printed on the nameplate. Grinders in use on the job must be similarly checked at least once each shift.
- Always use the Ingersoll-Rand Wheel Guard furnished with the Grinder.
- Do not use a Grinder without the recommended wheel guard. Do not use any wheel for which the operating speed listed on the blotter is lower than the actual free speed of the Grinder.
- Inspect all grinding wheels for chips or cracks prior to mounting. Do not use a wheel that is chipped or cracked or otherwise damaged. Do not use a wheel that has been soaked in water or any other liquid.
- Make certain the grinding wheel properly fits the arbor. The wheel should not fit too snugly or too loosely. Plain hole wheels should have about 0.007" (0.17 mm) maximum diametral clearance. Do not use reducing bushings to adapt a wheel to any arbor unless such bushings are supplied by or recommended by the wheel manufacturer.
- After mounting a new wheel, hold the Grinder under a steel workbench or inside a casting and run it for at least 60 seconds. Make certain no one is within the operating plane of the grinding wheel. If the wheel is defective, improperly mounted or the wrong size and speed, this is the time it will usually fail.
- When starting a cold wheel, apply it to the work slowly until the wheel gradually warms up. Make smooth contact with the work, and avoid any bumping action or excessive pressure.
- Always replace a damaged, bent or severely worn wheel guard. Do not use a wheel guard that has been subjected to a wheel failure.
- Make certain the wheel flanges are at least 1/3 the diameter of the grinding wheel, free of nicks and burrs and sharp edges. Always use the wheel flanges furnished by the manufacturer; never use a makeshift flange or a plain washer.
- Guard opening must face away from operator. Bottom of wheel must not project beyond guard.
- Always use a wheel blotter between each wheel flange and the wheel. The blotters must be at least as large in diameter as the wheel flanges.
- Do not attempt to disassemble the Controller. The Controller is available only as a unit and is guaranteed for the life of the tool if it is not abused.

## PLACING TOOL IN SERVICE

**WARNING:** Incorrect combinations of grinding wheel, wheel guard and tool speed could result in injury.  
Correct combinations are specified below:

Guard Part Number	Wheel Type	Wheel Diameter in. (mm)	Maximum Wheel Thickness in. (mm)	Maximum Speed rpm
99V60-A216A	6 and 11	5 (127) or 6 (150)	---	6,000
99V60-A216MA	6 and 11	5 (127) or 6 (150)	---	6,000
99V60-206-7	6 and 11	7 (180)	---	6,000
99V60-106-9	27 and 28	9 (230)	1/4 (6.4)	6,000
99V77-106-7	27 and 28	7 (180)	1/4 (6.4)	8,500

### LUBRICATION



#### Ingersoll-Rand No. 50

Always use an air line lubricator with these tools.  
We recommend the following Filter-Lubricator-Regulator Unit:

**For USA- No. C31-06-G00**

**Before starting the tool**, unless the air line lubricator is used, detach the air hose and inject about 1.5 cc of oil into the air inlet. **For models with a built-in oiler**, remove the Oil Chamber Plug from the Cylinder Case and fill the chamber.

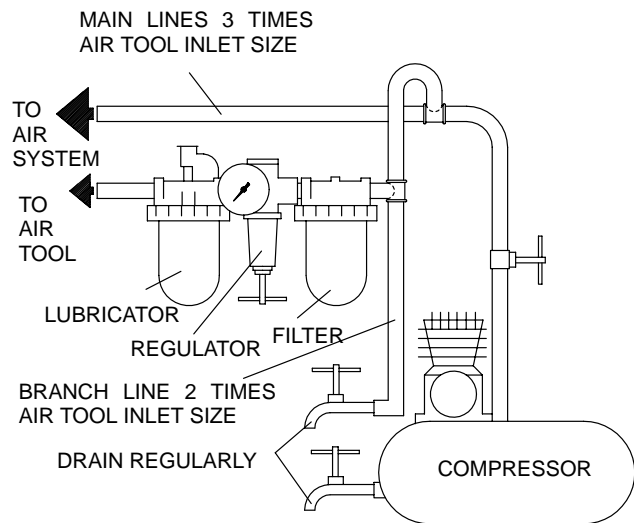

(Dwg. TPD905-1)

### HOW TO ORDER A GRINDER

#### VERTICAL DEPRESSED CENTER WHEEL GRINDER

Model	Free Speed L. C.	Type 27 and 28 Wheel inches	Spindle and Guard
99V60P107	6,000	7	5/8-11, 7"
99V60P109	6,000	9	5/8-11, 9"
99V77P107	7,700	7	5/8-11, 7"
99V85P107M	8,500	7	5/8-11, 7"

#### VERTICAL CUP WHEEL GRINDER

Model	Free Speed L. C.	Type 6 and 11 Wheel inches	Spindle and Guard
99V45S106	4,500	5 or 6	5/8-11, 6"
99V60S106	6,000	5 or 6	5/8-11, 6"

# MANUEL D'EXPLOITATION ET D'ENTRETIEN DES MEULEUSES VERTICALES DE LA SÉRIE 99V

F

## NOTE

Les meuleuses de la série 99V sont destinées au ponçage, à l'ébavurage ou à l'enlèvement du métal dans les fonderies, les chantiers navals, les aciéries et la construction.

Ingersoll-Rand ne peut être tenu responsable de la modification des outils par le client pour les adapter à des applications qui n'ont pas été approuvées par Ingersoll-Rand.

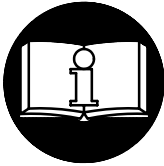

## ⚠ ATTENTION

**D'IMPORTANTES INFORMATIONS DE SECURITÉ SONT JOINTES.  
LIRE CE MANUEL AVANT D'UTILISER L'OUTIL.  
L'EMPLOYEUR EST TENU À COMMUNIQUER LES INFORMATIONS  
DE CE MANUEL AUX EMPLOYÉS UTILISANT CET OUTIL.**

**LE NON RESPECT DES AVERTISSEMENTS SUIVANTS PEUT CAUSER DES BLESSURES**

### MISE EN SERVICE DE L'OUTIL

- Toujours exploiter, inspecter et entretenir cet outil conformément au Code de sécurité des outils pneumatiques portatifs de l'American National Standards Institute (ANSI B186.1).
- Pour la sécurité, les performances optimales et la durabilité maximale des pièces, cet outil doit être connecté à une alimentation d'air comprimé de 6,2 bar (620kPa) maximum à l'entrée, avec un flexible de 19 mm de diamètre intérieur.
- Couper toujours l'alimentation d'air comprimé et débrancher le flexible d'alimentation avant d'installer, déposer ou ajuster tout accessoire sur cet outil, ou d'entreprendre une opération d'entretien quelconque sur l'outil.
- Ne pas utiliser des flexibles ou des raccords endommagés, effilochés ou détériorés.
- S'assurer que tous les flexibles et les raccords sont correctement dimensionnés et bien serrés. Voir Plan TPD905-1 pour un exemple type d'agencement des tuyauteries.
- Utiliser toujours de l'air sec et propre à une pression maximum de 6,2 bar. La poussière, les fumées corrosives et/ou une humidité excessive peuvent endommager le moteur d'un outil pneumatique.
- Ne jamais lubrifier les outils avec des liquides inflammables ou volatils tels que le kérosène, le gasol ou le carburant d'aviation.
- Ne retirer aucune étiquette. Remplacer toute étiquette endommagée.

### UTILISATION DE L'OUTIL

- Porter toujours des lunettes de protection pendant l'utilisation et l'entretien de cet outil.
- Porter toujours une protection acoustique pendant l'utilisation de cet outil.
- Tenir les mains, les vêtements fous et les cheveux longs, éloignés de l'extrémité rotative de l'outil.
- Prévoir, et ne pas oublier, que tout outil motorisé est susceptible d'à-coups brusques lors de sa mise en marche et pendant son utilisation.
- Garder une position équilibrée et ferme. Ne pas se pencher trop en avant pendant l'utilisation de cet outil. Des couples de réaction élevés peuvent se produire à, ou en dessous, de la pression d'air recommandée.
- La rotation des accessoires de l'outil peut continuer pendant un certain temps après le relâchement de la gâchette.
- Les outils pneumatiques peuvent vibrer pendant l'exploitation. Les vibrations, les mouvements répétitifs et les positions inconfortables peuvent causer des douleurs dans les mains et les bras. N'utiliser plus d'outils en cas d'inconfort, de picotements ou de douleurs. Consulter un médecin avant de recommencer à utiliser l'outil.
- Utiliser les accessoires recommandés par Ingersoll-Rand.
- Cet outil n'est pas conçu pour fonctionner dans des atmosphères explosives,
- Cet outil n'est pas isolé contre les chocs électriques,

## NOTE

L'utilisation de rechanges autres que les pièces d'origine Ingersoll-Rand peut causer des risques d'insécurité, réduire les performances de l'outil et augmenter l'entretien, et peut annuler toutes les garanties.

Les réparations ne doivent être effectuées que par des réparateurs qualifiés autorisés. Consultez votre Centre de Service Ingersoll-Rand le plus proche.

Adressez toutes vos communications au Bureau Ingersoll-Rand ou distributeur le plus proche.

© Ingersoll-Rand Company 2000

Imprimé aux É.U.



**To Buy Ingersoll Rand Products Online visit [AirToolPro.com](http://AirToolPro.com)**

Brought to you by Zampini Industrial Group - Factory Authorized Distribution Since 1987 - 1-800-353-4676

## SIGNIFICATION DES ETIQUETTES D'AVERTISSEMENT

**ATTENTION**

LE NON RESPECT DES AVERTISSEMENTS SUIVANTS PEUT CAUSER DES BLESSURES

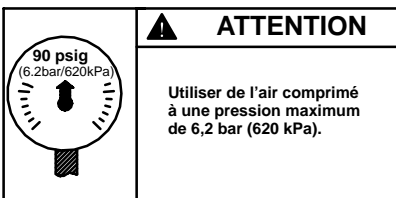
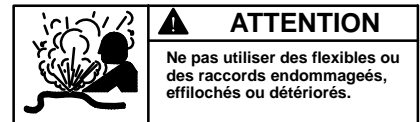
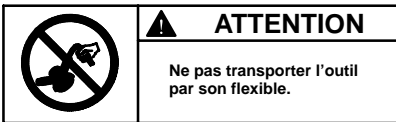
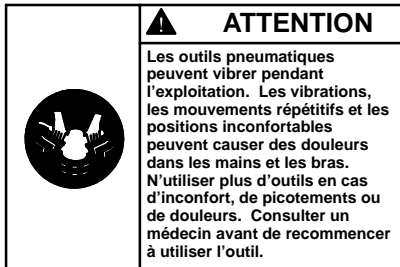
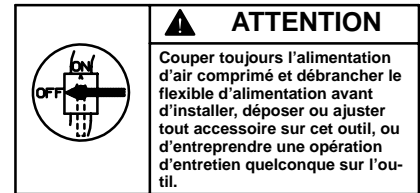
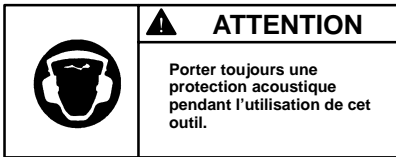
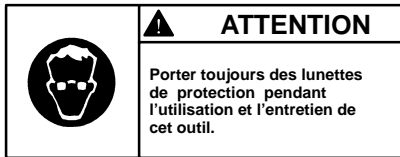

## AVERTISSEMENTS SPECIFIQUES AUX MEULEUSES

- Ne pas utiliser cet outil si la vitesse à vide réelle dépasse celle indiquée sur la plaque signalétique.
- Avant de monter une meule, après toute réparation de l'outil ou avant de fournir une meuleuse pour utilisation, vérifier la vitesse à vide de la meuleuse avec un tachymètre pour s'assurer que la vitesse réelle à 6,2 bar (620kPa) ne dépasse pas celle poinçonnée ou imprimée sur la plaque signalétique. Les meuleuses sorties sur chantier doivent être vérifiées de la même façon au moins une fois par poste.
- Utiliser toujours le protège-meule Ingersoll-Rand fourni avec la meuleuse.
- Ne jamais utiliser une meuleuse sans son protège-meule recommandé. Ne jamais utiliser de meule dont la vitesse de fonctionnement imprimée sur l'étiquette est inférieure à la vitesse à vide de meuleuse.
- Inspecter toutes les meules avant de les monter pour vérifier qu'elles ne présentent pas d'éclats ou de fissures. Ne jamais utiliser une meule écaillée, fissurée ou ayant un endommagement quelconque. Ne jamais utiliser une meule qui a été trempée dans l'eau ou tout autre liquide.
- S'assurer que la meule se monte correctement sur l'arbre. Le montage de la meule ne doit être ni serré ni libre. Les meules à trou lisse doivent présenter un jeu diamétral maximum de 0,17 mm. Ne pas utiliser de bagues réductrices, à moins que ces bagues soient recommandées et fournies par le fabricant de la meule.
- Après avoir monté une nouvelle meule, tenir la meuleuse sous un établi en acier ou dans une pièce coulée et la faire tourner pendant au moins 60 secondes. S'assurer que personne ne se tient dans le plan de rotation de la meule. Toute meule défectueuse, mal montée ou de dimension et vitesse incorrectes se cassera généralement à ce moment là.
- Pour commencer le travail avec une meule froide, l'appliquer lentement contre la pièce jusqu'à ce que la meule s'échauffe progressivement. Mettre la meule en contact avec la pièce en douceur en évitant tout choc ou pression excessive.
- Remplacer toujours un protège-meule endommagé, tordu ou très usé. Ne pas utiliser un protège-meule qui a été soumis à la rupture d'une meule.
- S'assurer que les flasques de meule couvrent au moins 1/3 du diamètre de la meule, et qu'ils sont exempts d'entailles, de bavures et d'arêtes vives. Utiliser toujours les flasques fournis par le fabricant; ne jamais utiliser de flasque de provenance douteuse ou de rondelle plate.
- L'ouverture du protège-meule doit être orientée côté opposé à l'opérateur. Le bas de la meule ne doit pas dépasser le protège-meule.
- Monter toujours un disque en buvard entre les flasques et la meule. Les disques doivent avoir un diamètre au moins égal à celui des flasques.
- Ne jamais essayer de démonter le contrôleur. Ce dernier est fourni seulement comme un ensemble et est garanti pendant toute la durée de vie de l'outil s'il est utilisé correctement.

## MISE EN SERVICE DE L'OUTIL

**ATTENTION:** Une mauvaise combinaison de roue d'affûtage, de protection de roue et de vitesse de l'outil peut provoquer un accident corporel. Les combinaisons correctes sont spécifiées ci-dessous:

Référence de la protection	Type de roue	Diamètre de roue mm (po.)	Épaisseur maximale de roue mm (po.)	Vitesse maximale (t/min)
99V60-A216A	6 et 11	127 (5) ou 150 (6)	---	6.000
99V60-A216MA	6 et 11	127 (5) ou 150 (6)	---	6.000
99V60-206-7	6 et 11	180 (7)	---	6.000
99V60-106-9	27 et 28	230 (9)	6,4 (1/4)	6.000
99V77-106-7	27 et 28	180 (7)	6,4 (1/4)	8.500

### LUBRIFICATION



Ingersoll-Rand N° 50

Utiliser toujours un lubrificateur avec ces outils. Nous recommandons l'emploi du filtre-régulateur-lubrificateur suivant :

É.U. - N° C31-06-G00

Toutes les deux ou trois heures de fonctionnement, si un lubrificateur de ligne n'est pas utilisé, débrancher le flexible d'alimentation et verser environ 1,5 cm<sup>3</sup> d'huile dans le raccord d'admission de l'outil. **Sur les modèles dotés d'un huileur incorporé**, déposer le bouchon de l'huileur du corps du cylindre et remplir la chambre d'huile.

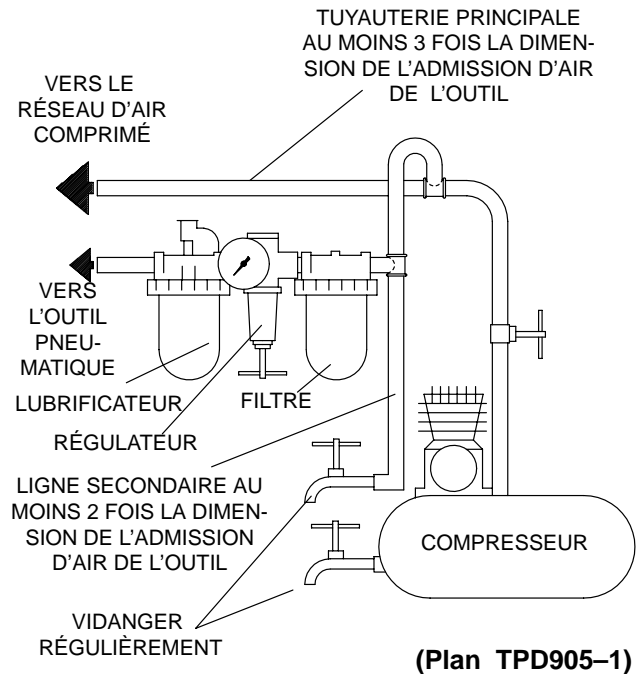

### SPÉCIFICATIONS

Modèle	Vitesse à vide	Meules Types 27 et 28	Arbre et protégé-meule
	L. C.	pouces	
99V60P107	6.000	7	5/8-11, 7"
99V60P109	6.000	9	5/8-11, 9"
99V77P107	7.700	7	5/8-11, 7"
99V85P107M	8.500	7	5/8-11, 7"
Modèle	Vitesse à vide	Meules Types 6 et 11	Arbre et protégé-meule
	L. C.	pouces	
99V45S106	4.500	5 ou 6	5/8-11, 6"
99V60S106	6.000	5 ou 6	5/8-11, 6"

# MANUEL DE USO Y MANTENIMIENTO PARA AMOLADORAS NEUMATICAS VERTICALES MODELO 99V

E

## NOTA

Las Amoladoras Modelo 99V están diseñadas para trabajos de pulido, recorte o eliminación de metal en fundiciones, astilleros, fábricas de acero y en la industria de construcción.

Ingersoll–Rand no aceptará responsabilidad alguna por la modificación de las herramientas efectuada por el cliente para las aplicaciones que no hayan sido consultadas con Ingersoll–Rand.



## ⚠ AVISO

**SE ADJUNTA INFORMACION IMPORTANTE DE SEGURIDAD.  
LEA ESTE MANUAL ANTES DE USAR LA HERRAMIENTA.**

**ES RESPONSABILIDAD DE LA EMPRESA ASEGURARSE DE QUE EL OPERARIO  
ESTE AL TANTO DE LA INFORMACION QUE CONTIENE ESTE MANUAL.**

**EL HACER CASO OMISO DE LOS AVISOS SIGUIENTES PODRIA OCASIONAR LESIONES.**

### PARA PONER LA HERRAMIENTA EN SERVICIO

- Utilice, examine y mantenga siempre esta herramienta conforme al código de seguridad para herramientas neumáticas portátiles de la American National Standards Institute (ANSI B186.1).
- Para mayor seguridad y para obtener los mejores resultados y la máxima vida de servicio de las piezas, maneje esta herramienta a una presión de aire máxima de 90 psig (6,2 bar/620 kPa) con una manguera de suministro de aire con un diámetro interior de 19 mm.
- Corte siempre el suministro de aire y desconecte la manguera de suministro de aire antes de instalar, desmontar o ajustar cualquier accesorio de esta herramienta, o antes de realizar cualquier operación de mantenimiento de la misma.
- No utilice mangueras de aire y accesorios dañados, desgastados ni deteriorados.
- Asegúrese de que todas las mangueras y los accesorios sean del tamaño correcto y estén bien apretados. Vea Esq. TPD005–1 para un típico arreglo de tuberías.
- Use siempre aire limpio y seco a una máxima presión de 90 psig. El polvo, los gases corrosivos y/o el exceso de humedad podrían estropear el motor de una herramienta neumática.
- No lubrique las herramientas con líquidos inflamables o volátiles tales como queroseno, gasoil o combustible para motores a reacción.
- No saque ninguna etiqueta. Sustituya toda etiqueta dañada.

### USO DE HERRAMIENTA

- Use siempre protección ocular cuando utilice esta herramienta o realice operaciones de mantenimiento en la misma.
- Use siempre protección para los oídos cuando utilice esta herramienta.
- Mantenga las manos, la ropa suelta y el cabello largo alejados del extremo giratorio de la herramienta.
- Anticipe y esté alerta a los cambios repentinos en el movimiento durante la puesta en marcha y el manejo de toda herramienta motorizada.
- Mantenga una postura de cuerpo equilibrada y firme. No estire demasiado los brazos al manejar la herramienta. Pueden ocurrir reacciones de alto par a, o menos de, la recomendada presión de aire.
- Los accesorios de la herramienta podrían seguir girando brevemente después de haber soltado la palanca de estrangulación.
- Las herramientas neumáticas pueden vibrar durante el uso. La vibración, repetición o posiciones incómodas pueden dañarle los brazos y manos. En caso de incomodidad, sensación de hormigueo o dolor, deje de usar la herramienta. Consulte a un médico antes de volver a usarla otra vez.
- Utilice únicamente los accesorios Ingersoll–Rand recomendados.
- Esta herramienta no ha sido diseñada para trabajar en ambientes explosivos.
- Esta herramienta no está aislada contra descargas eléctricas.

## NOTA

El uso de piezas de recambio que no sean las auténticas piezas Ingersoll–Rand podría poner en peligro la seguridad, reducir el rendimiento de la herramienta y aumentar los cuidados de mantenimiento necesarios, así como invalidar toda garantía.

Las reparaciones sólo serán realizadas por personal cualificado y autorizado. Consulte con el centro de servicio Ingersoll–Rand autorizado más próximo.

Toda comunicación se deberá dirigir a la oficina o al distribuidor Ingersoll–Rand más próximo.

© Ingersoll–Rand Company 2000

Impreso en EE.UU.



**To Buy Ingersoll Rand Products Online visit [AirToolPro.com](http://AirToolPro.com)**

Brought to you by Zampini Industrial Group - Factory Authorized Distribution Since 1987 - 1-800-353-4676

## ETIQUETAS DE AVISO

### ⚠ AVISO

EL HACER CASO OMISO DE LOS AVISOS SIGUIENTES PODRIA OCASIONAR LESIONES.

	<p><b>⚠ ADVERTENCIA</b></p> <p>Use siempre protección ocular cuando utilice esta herramienta o realice operaciones de mantenimiento en la misma.</p>
---	--

	<p><b>⚠ ADVERTENCIA</b></p> <p>Use siempre protección para los oídos cuando utilice esta herramienta.</p>
---	---

	<p><b>⚠ ADVERTENCIA</b></p> <p>Cortar siempre el suministro de aire y desconectar la manguera de suministro de aire antes de instalar, retirar o ajustar cualquier accesorio de esta herramienta, o antes de realizar cualquier operación de mantenimiento de la misma.</p>
---	---

	<p><b>⚠ ADVERTENCIA</b></p> <p>Las herramientas neumáticas pueden vibrar durante el uso. La vibración, los movimientos repetitivos o las posiciones incómodas podrían dañarle los brazos y las manos. En caso de incomodidad, sensación de hormigueo o dolor, dejar de usar la herramienta. Consultar al médico antes de volver a utilizarla.</p>
---	---

	<p><b>⚠ ADVERTENCIA</b></p> <p>No coger la herramienta por la manguera para levantarla.</p>
---	---

	<p><b>⚠ ADVERTENCIA</b></p> <p>No utilizar mangueras de aire y accesorios dañados, desgastados ni deteriorados.</p>
---	---

	<p><b>⚠ ADVERTENCIA</b></p> <p>Mantener una postura del cuerpo equilibrada y firme. No estirar demasiado los brazos al manejar la herramienta.</p>
---	--

	<p><b>⚠ ADVERTENCIA</b></p> <p>Manejar la herramienta a una presión de aire máxima de 90 psig (6,2 bar/620 kPa).</p>
---	--

## AVISOS ESPECIFICOS DE AMOLADORA

- No use esta herramienta si la actual velocidad constante excede la indicada en la placa de identificación.
- Antes de montar una muela, y después de todas las reparaciones de herramienta y siempre que se ofrezca una Amoladora para uso, compruebe la velocidad constante de la Amoladora con un tacómetro para asegurarse que su velocidad actual a 90 psig (6,2 bar/620 kPa) no exceda las rpm estampadas o impresas en la placa de identificación. Las Amoladoras en uso en el trabajo deberán ser similarmente comprobadas como mínimo en cada turno.
- Use siempre el Cubremuela de muela Ingersoll-Rand suministrado con la Amoladora.
- No use una Amoladora sin el cubremuela recomendado. No use ninguna muela que tenga un registro de velocidad listado menor a la actual velocidad constante de Amoladora.
- Inspeccione todas las muelas antes de su montaje para ver si tienen grietas o roturas. No use una muela que esté rota o agrietada o de cualquier otra forma dañada. No use una muela que haya sido empapada en agua o en cualquier otro líquido.
- Asegúrese que la muela esté bien fijada en el eje. La muela no debe estar muy floja ni muy apretada. Las muelas de orificio normal deberán tener así como 0,007" (0,17 mm) de máxima holgura diamétrica. No use aros reductores para adaptar una muela al eje a menos que estos hayan sido suministrados o recomendados por el fabricante de muelas.
- Después de haber montado una nueva muela, sujete la Amoladora debajo de un banco de acero o en un molde y funciónela por como mínimo 60 segundos. Asegúrese que no haya nadie en el entorno de operación de muela. Si la muela es defectuosa, está mal montada o es del tamaño y velocidad incorrecta, normalmente fallará en este tiempo.
- Cuando inicie una muela fría, aplíquela lentamente al trabajo hasta que la muela se caliente gradualmente. Contacte el trabajo suavemente, y evite acción de saltos o exceso de presión.
- Cambie siempre un cubremuela dañado, torcido o severamente desgastado. No use un cubremuela que haya estado sujeto a un fallo de muela.
- Asegúrese que las bridas de muela sean de un diámetro mínimo de 1/3" de la muela y que estén libres de marcas, rebabas y bordes afilados. Use siempre las bridas de muela suministradas por el fabricante. No use nunca una brida casera o arandela plana.
- La apertura de cubre muela deberá estar orientada hacia afuera del operario. La parte inferior de la muela no deberá proyectarse fuera del cubremuela.
- Use siempre un distanciador entre cada brida de muela y muela. Los distanciadores deberán ser de un diámetro mínimo igual al de bridas de muela.
- No trate de desmontar el Controlador. El Controlador está solamente disponible como unidad y está garantizado por toda la vida útil de herramienta, si no se abusa.



## PARA PONER LA HERRAMIENTA EN SERVICIO

**AVISO:** Combinaciones incorrectas de rueda de rectificación, protector de rueda y velocidad de herramienta puedan resultar en lesionamientos. Las combinaciones correctas se especifican a continuación:

Número de Pieza del Protector	Tipo de Rueda	Diámetro de Rueda mm (in.)	Grosor Máximo de Rueda mm (in.)	Velocidad Máxima (rpm)
99V60-A216A	6 y 11	127 (5) o 150 (6)	---	6.000
99V60-A216MA	6 y 11	127 (5) o 150 (6)	---	6.000
99V60-206-7	6 y 11	180 (7)	---	6.000
99V60-106-9	27 y 28	230 (9)	6,4 (1/4)	6.000
99V77-106-7	27 y 28	180 (7)	6,4 (1/4)	8.500

### LUBRICACION



**Ingersoll-Rand N° 50**

Utilice siempre un lubricador de aire comprimido con esta herramienta de impacto. Recomendamos la siguiente unidad de Filtro-Lubricador-Regulador:

**EE.UU.- N°. C31-06-G00**

Antes de poner la herramienta en marcha, a menos que se haya puesto lubricante de línea de aire comprimido, desconecte la manguera de aire e inyecte 1,5 cc de aceite en la admisión de aire. **Modelos con lubricador incorporado:** saque el tapón de la cámara de aceite de la carcasa del cilindro y llene la cámara.

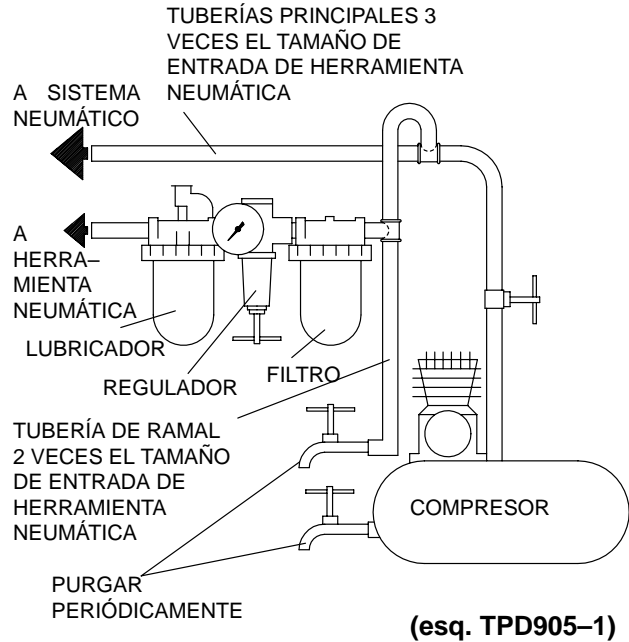

(esq. TPD905-1)

### ESPECIFICACIONES

Modelo	Velocidad Constante	Muela Tipo 27 y 28	Eje y Cubremuela
	<b>L. C.</b>	<b>pulgadas</b>	
99V60P107	6.000	7	5/8-11, 7"
99V60P109	6.000	9	5/8-11, 9"
99V77P107	7.700	7	5/8-11, 7"
99V85P107M	8.500	7	5/8-11, 7"
Modelo	Velocidad Constante	Muela Tipo 6 y 11	Eje y Cubremuela
	<b>L. C.</b>	<b>pulgadas</b>	
99V45S106	4.500	5 ó 6	5/8-11, 6"
99V60S106	6.000	5 ó 6	5/8-11, 6"

# MANUAL DE FUNCIONAMENTO E MANUTENÇÃO PARA RECTIFICADORES PNEUMÁTICOS VERTICAIS SÉRIE 99V

P

## AVISO

Os Rectificadores Série 99V são concebidos para aplanar, aparar ou remover metal em fundições, estaleiros, aciarias e em aplicações de construção.

A Ingersoll-Rand não pode ser responsabilizada pela modificação de ferramentas para aplicações para as quais não tenha sido consultada.

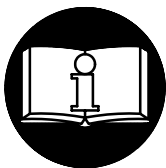

## ⚠️ ADVERTÊNCIA

**IMPORTANTES INFORMAÇÕES DE SEGURANÇA EM ANEXO.  
LEIA ESTE MANUAL ANTES DE OPERAR A FERRAMENTA.  
É RESPONSABILIDADE DA ENTIDADE PATRONAL PÔR AS INFORMAÇÕES  
CONTIDAS NESTE MANUAL À DISPOSIÇÃO DOS UTILIZADORES.**

**A NÃO OBEDEÊNCIA ÀS ADVERTÊNCIAS SEGUINTE PODERÁ RESULTAR EM LESÕES PESSOAIS.**

### COLOCAÇÃO DA FERRAMENTA EM SERVIÇO

- Sempre opere, inspeccione e mantenha esta ferramenta de acordo com o Código de Segurança do Instituto Americano de Padrões Nacionais para Ferramentas Pneumáticas Portáteis (ANSI B186.1).
- Para segurança, desempenho superior e durabilidade máxima das peças, opere esta ferramenta a uma pressão de ar máxima de 90 psig (6,2 bar/620 kPa) na admissão com uma mangueira de alimentação de ar com diâmetro interno de 3/4 pol. (19 mm).
- Desligue sempre a alimentação de ar e a mangueira de alimentação de ar antes de instalar, retirar ou ajustar qualquer acessório desta ferramenta, ou antes de fazer manutenção na mesma.
- Não utilize mangueiras de ar e acessórios danificados, puídos ou deteriorados.
- Certifique-se de que todas as mangueiras e acessórios são da dimensão correcta e que estão seguros firmemente. Consulte o Des. TPD905-1 para uma disposição de tubos típica.
- Utilize sempre ar limpo e seco a uma pressão máxima de 90 psig. Poeira, fumos corrosivos e/ou humidade excessiva podem destruir o motor de uma ferramenta pneumática.
- Não lubrifique a ferramenta com líquidos inflamáveis ou voláteis como querosene, gasóleo ou combustível para jactos.
- Não retire nenhum rótulo. Substitua os rótulos danificados.

### UTILIZAÇÃO DA FERRAMENTA

- Use sempre protecção para os olhos ao operar ou fazer manutenção nesta ferramenta.
- Use sempre protecção auricular ao operar esta ferramenta.
- Mantenha as mãos, roupas soltas e cabelos longos afastados da extremidade rotativa da ferramenta.
- Esteja preparado e alerta para mudanças súbitas no movimento durante o arranque e o funcionamento de qualquer ferramenta mecânica.
- Mantenha o corpo numa posição equilibrada e firme. Não estique o corpo ao operar esta ferramenta. Podem ocorrer binários de reacção elevados à ou abaixo da pressão do ar recomendada.
- Os acessórios da ferramenta podem continuar a rodar por um curto período de tempo depois de soltar o regulador.
- A ferramentas pneumáticas podem vibrar durante a utilização. Vibração, movimentos repetitivos ou posições desconfortáveis podem ser nocivos às suas mãos e braços. Pare de utilizar qualquer ferramenta se ocorrer desconforto, sensação de formigueiro ou dor. Procure assistência médica antes de reiniciar a utilização.
- Use os acessórios recomendados pela Ingersoll-Rand.
- Esta ferramenta não é concebida para funcionar em atmosferas explosivas.
- Esta ferramenta não é isolada contra choque eléctrico.

## AVISO

A utilização de qualquer peça sobresselente que não seja Ingersoll-Rand genuína pode resultar em riscos para a segurança, em desempenho reduzido da ferramenta e mais necessidade de manutenção, e pode invalidar todas as garantias.

As reparações só devem ser feitas por pessoal autorizado e com formação adequada. Consulte o Representante Autorizado Ingersoll-Rand mais próximo.

Envie toda a correspondência ao Escritório  
ou Distribuidor Ingersoll-Rand mais próximo.  
© Ingersoll-Rand Company 2000

Impresso nos E.U.A.



**To Buy Ingersoll Rand Products Online visit [AirToolPro.com](http://AirToolPro.com)**

Brought to you by Zampini Industrial Group - Factory Authorized Distribution Since 1987 - 1-800-353-4676

# IDENTIFICAÇÃO DAS ETIQUETAS DE ADVERTÊNCIA

## ⚠ ADVERTÊNCIA

A NÃO OBEDIÊNCIA ÀS ADVERTÊNCIAS SEGUINTESS PODERÁ RESULTAR EM LESÕES PESSOAIS.

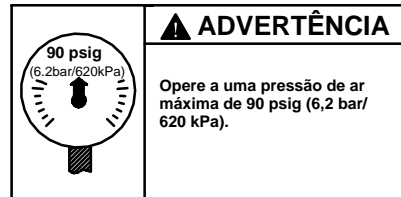
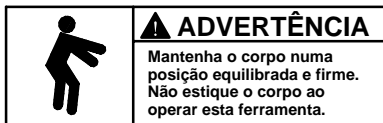
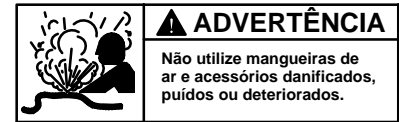
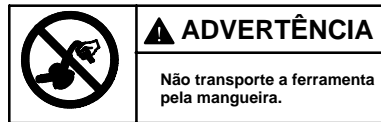

## ADVERTÊNCIAS ESPECÍFICAS PARA O RECTIFICADOR

- Não utilize esta ferramenta se a velocidade livre real ultrapassar o valor de rpm indicado na placa de identificação.
- Antes de montar uma mó abrasiva, após todas as reparações da ferramenta ou sempre que o Rectificador for ser utilizado, verifique a velocidade livre do mesmo com um taquímetro para assegurar que a sua velocidade real a 90 psig (6,2 bar/620 kPa) não ultrapassa o valor de rpm gravado ou impresso na placa de identificação. Os rectificadores em uso numa tarefa devem ser verificados da mesma maneira, pelo menos uma vez em cada turno.
- Utilize sempre a Protecção de Mó Abrasiva Ingersoll-Rand fornecida com o Rectificador.
- Não utilize um Rectificador sem a protecção de mó abrasiva recomendada. Não utilize nenhuma mó abrasiva cuja velocidade de funcionamento listada na anilha de sujeição seja inferior à velocidade livre do Rectificador.
- Inspeccione todas as mós abrasivas quanto a lascas ou rachas antes de as montar. Não utilize uma mó que esteja lascada, rachada, ou danificada de alguma maneira. Não utilize uma mó que tenha estado mergulhada em água ou em outro líquido qualquer.
- Certifique-se de que a mó abrasiva encaixa correctamente no veio. A mó abrasiva não deve encaixar demasiado apertada ou frouxa. As mós com orifício liso devem ter uma folga diametral máxima de cerca de 0,007 pol. (0,17 mm). Não utilize buchas redutoras para adaptar uma mó abrasiva a um veio, a menos que a bucha seja fornecida ou recomendada pelo fabricante da mó.
- Depois de montar uma mó abrasiva nova, segure o Rectificador sob uma bancada de aço ou dentro de uma peça fundida e ponha-o a funcionar durante pelo menos 60 segundos. Certifique-se de que não há ninguém dentro do plano de operação da mó abrasiva. Se a mó estiver com defeito, montada incorrectamente ou for de tamanho ou velocidade errada, é geralmente nesta altura que ela falhará.
- Ao começar a trabalhar com uma mó fria, aplique-a ao trabalho lentamente, até a mó aquecer gradualmente. Faça contacto suave com o trabalho e evite qualquer acção instável ou pressão excessiva.
- Substitua sempre uma protecção de mó abrasiva danificada, curvada ou muito gasta. Não utilize uma protecção que tenha sido sujeita a uma falha de mó abrasiva.
- Certifique-se de que as flanges da mó têm pelo menos 1/3 do diâmetro da mó abrasiva, estão livres de entalhes e rebarbas e de bordas afiadas. Utilize sempre as flanges de mó fornecidas pelo fabricante; nunca utilize uma flange improvisada ou uma anilha comum.
- A abertura da protecção deve ficar voltada para longe do operador. O fundo da mó não deve ficar saliente além da protecção.
- Utilize sempre uma anilha de sujeição de mó abrasiva entre cada flange de mó e a mó. As anilhas de sujeição devem ter, pelo menos, o mesmo diâmetro das flanges de mó.
- Não tente desmontar o Controlador. O Controlador só está disponível como uma unidade e é garantido durante a vida útil da ferramenta, se não for maltratado.

## COLOCAÇÃO DA FERRAMENTA EM SERVIÇO

### ADVERTÊNCIA:

Combinações incorrectas de mó abrasiva, protecção da mó abrasiva e velocidade da ferramenta podem resultar em lesões pessoais. As combinações correctas estão especificadas abaixo:

Número de Peça da Protecção	Tipo de Mó Abrasiva	Diâmetro da Mó pol. (mm)	Espessura Máxima da Mó pol. (mm)	Velocidade Máxima rpm
99V60-A216A	6 e 11	5 (127) ou 6 (150)	---	6.000
99V60-A216MA	6 e 11	5 (127) ou 6 (150)	---	6.000
99V60-206-7	6 e 11	7 (180)	---	6.000
99V60-106-9	27 e 28	9 (230)	1/4 (6,4)	6.000
99V77-106-7	27 e 28	7 (180)	1/4 (6,4)	8.500

## LUBRIFICAÇÃO



Ingersoll-Rand Nº 50

Utilize sempre um lubrificador de linha de ar com estas ferramentas.

Recomendamos a seguinte Unidade Filtro-Lubrificador-Regulador:

**Para E.U.A. - Nº. C31-06-G00**

**Antes de ligar a ferramenta**, a menos que o lubrificador de linha de ar esteja a ser utilizado, desligue a mangueira de ar e injecte aproximadamente 1,5 cc de óleo na admissão de ar.

**Para modelos com lubrificador incorporado**, remova o bujão de óleo da câmara da caixa do cilindro e encha a câmara.

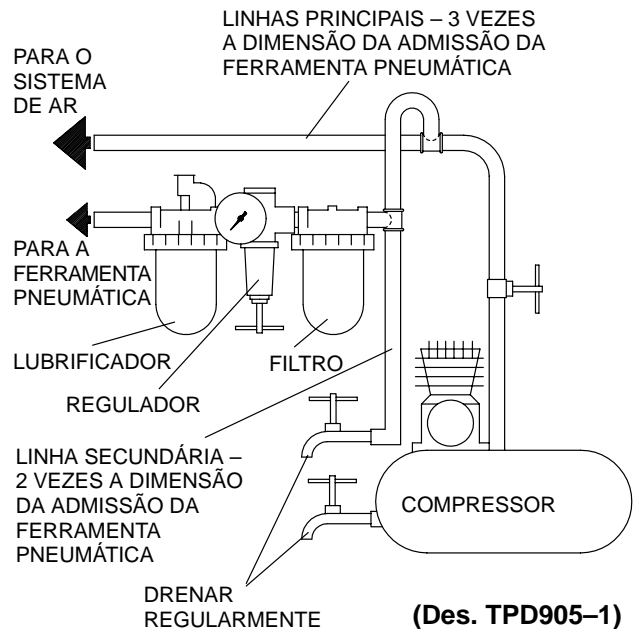

## ESPECIFICAÇÕES

Modelo	Velocidade Livre	Mó Abrasiva Tipo 27 e 28	Haste e Protecção
	<b>L. C.</b>	<b>polegadas</b>	
99V60P107	6.000	7	5/8-11, 7"
99V60P109	6.000	9	5/8-11, 9"
99V77P107	7.700	7	5/8-11, 7"
99V85P107M	8.500	7	5/8-11, 7"
Modelo	Velocidade Livre	Mó Abrasiva Tipo 6 e 11	Haste e Protecção
	<b>L. C.</b>	<b>polegadas</b>	
99V45S106	4.500	5 ou 6	5/8-11, 6"
99V60S106	6.000	5 ou 6	5/8-11, 6"



**USE THIS PART LISTING WITH DRAWING TPA1708 FOR MODELS WITHOUT BUILT-IN OILERS**



**PART NUMBER FOR ORDERING**

**PART NUMBER FOR ORDERING**

+ 1	Cylinder Case Assembly for models ending in -EU . . . . .	99V60-EU-A25A	19	Exhaust Deflector . . . . .	99V60-23
	for all other models . . . . .	99V60-A25A	20	Exhaust Deflector Screw (3) . . . . .	99V60-200
2	Throttle Valve Assembly . . . . .	88V60-A302	*	Nameplate Kit (for European compliant models) . . . . .	99V-EU-K301A
3	Throttle Seal (2) . . . . .	C321-606	*	Nameplate Screw (for European compliant models) (4) . . . . .	BN403-302
5	Inlet Bushing . . . . .	88V60-38	*	Warning Label (for European compliant models) . . . . .	EU-99
• 5A	Inlet Bushing Screen . . . . .	834-61	*	Nameplate Kit (for domestic models) . . . . .	99V-K301A
• 6	Throttle Valve Spring . . . . .	99V60-262		Nameplate Screw (4) . . . . .	BN403-302
7	Throttle Valve Seat Support Assembly . . . . .	88V60-A303		Warning Label . . . . .	WARNING-4-99
• 8	Air Strainer Screen . . . . .	834-61	27	Dead Handle . . . . .	ERG0-A48
• 10	Valve Seat . . . . .	R4-159A	29	Arbor for 99V45 (Orange) . . . . .	99V45-204-P10
11	Valve Seat Washer . . . . .	99V60-155		for 99V60 (Blue) . . . . .	99V60-204-P10
12	Valve Seat Lock Washer . . . . .	H54U-352		for 99V77 (Green) . . . . .	99V77-204-P10
13	Valve Seat Screw . . . . .	PS3-83		for 99V85 (Red) . . . . .	99V85-204-P10
14	Throttle Lever Pin . . . . .	MR-100	30	Front Rotor Bearing . . . . .	R380-105
15	Locking Lever Assembly . . . . .	88V60-A400	31	Front End Plate . . . . .	99V60-11
16	Lever Lock . . . . .	88V60-402			
17	Lever Lock Spring . . . . .	88V60-405			
18	Lever Lock Pin . . . . .	502B-120			
18A	Exhaust Diffuser (not used on 99V45 or 99V60) . . . . .	99V77-123			

\* Not illustrated.

• To keep downtime to a minimum, it is desirable to have on hand certain repair parts. We recommend that you stock one (pair or set) of each part indicated by a bullet (•) for every four tools in service.

+ Whenever a new Cylinder Case Assembly is installed, select the correct Nameplate from the Nameplate Kit and attach it to the Cylinder case with the Nameplate Screws.

USE THIS DRAWING WITH PART LISTING FOR MODELS WITH BUILT-IN OILERS

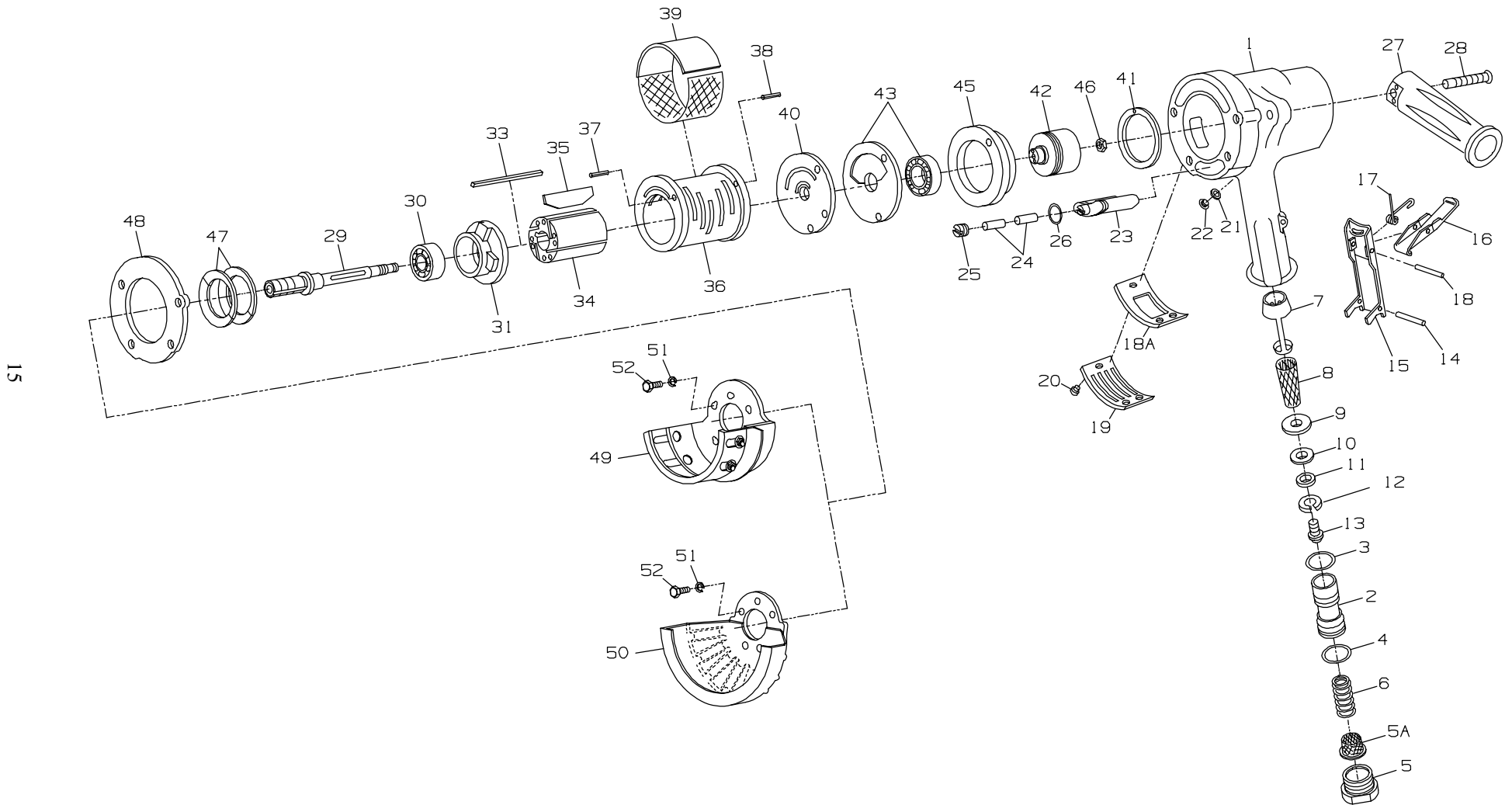

(Dwg. TPA717-3)



**USE THIS PART LISTING WITH DRAWING TPA717-3 FOR MODELS WITH BUILT-IN OILERS**

**PART NUMBER FOR ORDERING**

**PART NUMBER FOR ORDERING**

+ 1	Cylinder Case Assembly . . . . .	—	*	Nameplate Kit (for European compliant models) . . . . .	99V-EU-K301
2	Throttle Valve Assembly . . . . .	99V60-A302	*	Nameplate Screw (for European compliant models) (4) . . . . .	BN403-302
◆ 3	Small Seal . . . . .	AFH120A-358	*	Warning Label (for European compliant models) . . . . .	EU-99
◆ 4	Large Seal . . . . .	C321-606	*	Nameplate Kit (for domestic models) . . . . .	99V-K301
5	Inlet Bushing . . . . .	88V60-38		Nameplate Screw (4) . . . . .	BN403-302
◆• 5A	Inlet Bushing Screen . . . . .	834-61		Warning Label . . . . .	WARNING-4-99
• 6	Throttle Valve Spring . . . . .	99V60-262	◆ 21	Oiler Chamber Plug Washer . . . . .	R3-92A
7	Throttle Valve Seat Support Assembly . . . . .	99V60-A303	22	Oiler Chamber Plug . . . . .	231-665
◆• 8	Air Strainer Screen . . . . .	99V60-61	23	Oiler Assembly . . . . .	99V60-A198
9	Valve Seat Cap . . . . .	R4-157	◆ 24	Oiler Felt (2) . . . . .	R1-75
◆• 10	Valve Seat . . . . .	R4-159A	25	Oiler Adjusting Screw . . . . .	R1-71A
11	Valve Seat Washer . . . . .	99V60-155	◆ 26	Oiler Body Seal . . . . .	HRA20A-117
12	Valve Seat Lock Washer . . . . .	H54U-352	27	Dead Handle . . . . .	99V60-48
13	Valve Seat Screw . . . . .	99V60-83	28	Dead Handle Screw . . . . .	99V60-634
• 14	Throttle Lever Pin . . . . .	MR-100	29	Arbor	
15	Locking Lever Assembly . . . . .	99V60-A400A		for 99V45 (Orange) . . . . .	99V45-204-P10
16	Lever Lock . . . . .	88V60-402		for 99V60 (Blue) . . . . .	99V60-204-P10
17	Lever Lock Spring . . . . .	88V60-405		for 99V77 (Green) . . . . .	99V77-204-P10
18	Lever Lock Pin . . . . .	502B-120		for 99V85 (Red) . . . . .	99V85-204-P10
18A	Exhaust Diffuser (not used on 99V45 or 99V60) . . . . .	99V77-123	30	Front Rotor Bearing . . . . .	R380-105
19	Exhaust Deflector . . . . .	99V60-23	31	Front End Plate . . . . .	99V60-11
20	Exhaust Deflector Screw (3) . . . . .	99V60-200			

16

- \* Not illustrated.
- ◆ Indicates Tune-up Kit part.
- To keep downtime to a minimum, it is desirable to have on hand certain repair parts. We recommend that you stock one (pair or set) of each part indicated by a bullet (•) for every four tools in service.
- + Whenever a new Cylinder Case Assembly is installed, select the correct Nameplate from the Nameplate Kit and attach it to the Cylinder case with the Nameplate Screws.

**To Buy Ingersoll Rand Products Online visit [AirToolPro.com](http://AirToolPro.com)**

Brought to you by Zampini Industrial Group - Factory Authorized Distribution Since 1987 - 1-800-353-4676



**USE THIS PART LISTING FOR ALL MODELS**

**PART NUMBER FOR ORDERING** 

**PART NUMBER FOR ORDERING** 

• 33	Rotor Key . . . . .	R43F-70	50	Depressed Center Wheel Guard for Type 27 or Type 28 Wheels	
34	Rotor . . . . .	99V60-53		for 9" or 230 mm . . . . .	99V60-106-9
◆• 35	Vane Packet (set of 4 Vanes) . . . . .	99V60-42-4		for 7" or 180 mm . . . . .	99V77-106-7
36	Cylinder Assembly . . . . .	99V60-A3	50A	Saucer Wheel Guard (for 7" diameter x 1" thick x 1-5/8" over all height Saucer Wheel) . . . . .	99V60-206-7
37	End Plate Dowel . . . . .	5040-6	51	Cylinder Case Screw Lock Washer (4) . . . . .	10BM-67
38	Cylinder Dowel . . . . .	502B-120	52	Cylinder Case Screw (4) . . . . .	99V60-638
39	Exhaust Silencer . . . . .	99V60-311	53	Autobalancer Assembly . . . . .	99V60-A713
40	Rear End Plate . . . . .	99V60-A12	54	Autobalancer Wrench (7/8" single-end; open-end wrench) . . . . .	88V60-169
◆• 41	Rear End Plate Gasket . . . . .	99V60-739	56	Wheel Retaining Screw	
42	Controller Assembly (consists of Controller and Rotor Bearing Seal Assembly)			for all Type 27 and Type 28 Wheels	99V60-219
	for 99V45 (4500 rpm) (Orange)	99V45-A524		for 7" diameter x 1" thick x 1-5/8" overall height Saucer Wheels . . . . .	99V60-119
	for 99V60 (6000 rpm) (Blue) . . . . .	99V60-A524	56A	Wheel Retaining Screw Assembly (for all Type 6 and Type 11 Wheels) . . . . .	99V60-A219A
	for 99V77 (7700 rpm) (Green) . . . . .	99V77-A524	57	Depressed Center Wheel Spacer (for Type 27 Plain Hole Wheels) (2) . . . . .	99V-286
	for 99V85 (8500 rpm) (Red) . . . . .	99V85-A524	58	Depressed Center Wheel Flange (for 7" and 9" diameter Type 27 and Type 28 Plain Hole Wheels)	99V60-386
43	Rotor Bearing Seal Assembly (consists of Rear Rotor Bearing and Rotor Bearing Seal) . . . . .	99V60-A28A	59	Depressed Center Wheel Flange (for 99V60P107M, 99V60P109M and 99V85P107M Type 27 Plain Hole Depressed Center Wheels) . . . . .	99V60-386-M
45	Rotor Bearing Cage . . . . .	99V60-107A			
46	Controller Retaining Nut				
	for 99V45 and 99V85 . . . . .	R4-120			
	for all others . . . . .	G8-120A			
47	Motor Clamp Belleville Washer (2) . . . . .	99V60-207			
◆• 48	Cylinder Case Gasket . . . . .	99V60-283			
49	Cup Wheel Guard				
	for 5" or 6" Cup Wheels . . . . .	99V60-A216A			
	for 130 or 150 mm Cup Wheels . . . . .	99V60-A216MA			

17

- ◆ Indicates Tune-up Kit part.
- To keep downtime to a minimum, it is desirable to have on hand certain repair parts. We recommend that you stock one (pair or set) of each part indicated by a bullet (•) for every four tools in service.

**To Buy Ingersoll Rand Products Online visit [AirToolPro.com](http://AirToolPro.com)**

Brought to you by Zampini Industrial Group - Factory Authorized Distribution Since 1987 - 1-800-353-4676

**USE THIS PART LISTING FOR ALL MODELS**

**PART NUMBER FOR ORDERING** 

**PART NUMBER FOR ORDERING** 

61	Depressed Center Wheel Nut . . . . .	99V85-186	*	Tune-up Kit (for models with built-in	
62	Depressed Center Wheel Nut Spanner Wrench . . .	D32-26		oiler) (includes illustrated parts 3, 4 [2], 5A [2], 8,	
63	Depressed Center Wheel Flange Wrench (for 99V60P107M,99V60P109M and 99V85P107M) (1" x 15/16" double-end; open-end wrench) . . . . .	7RAQT4-254		10, 21, 24 [2], 26,35, 41 and 48) . . . . .	99V/99H-TK3
65	Flange (for 99V45S106M, 99V60S106M, 99V45S106M-EU, 99V45S106, and 99V60S106) . . . . .	88V60-86A		* Exhaust Deflector Screw Wrench (1/8" hex) . . . .	R2J-562
*	Piped-Away Exhaust Kit . . . . .	99V60-K184		* Maintenance Tool Kit . . . . .	99V60-K950
	Exhaust Hose . . . . .	99V60-184		Controller Wrench . . . . .	99V60-950
	Exhaust Hose Clamp . . . . .	DG30-67		Seal Pressing Tool . . . . .	99V60-951
	Exhaust Elbow . . . . .	99V60-167		Bearing Clamp . . . . .	99V60-A952
	Exhaust Elbow Gasket . . . . .	99V60-49		* Wheel Retaining Screw Wrench (5/32" hex) . . . .	88V-562
	Exhaust Elbow Screw (3) . . . . .	FEA100-112			
	Exhaust Hose Band (4) . . . . .	99V60-927			
	Exhaust Hose Band Screw (4) . . . . .	MT1-36-7/8			
	Nut (6) . . . . .	G8-120A			
	Screw (2) . . . . .	JC3350-103			

\* Not illustrated.

**Guards, Flanges and Spacers for 99V Grinders  
Using Depressed Center Wheels**

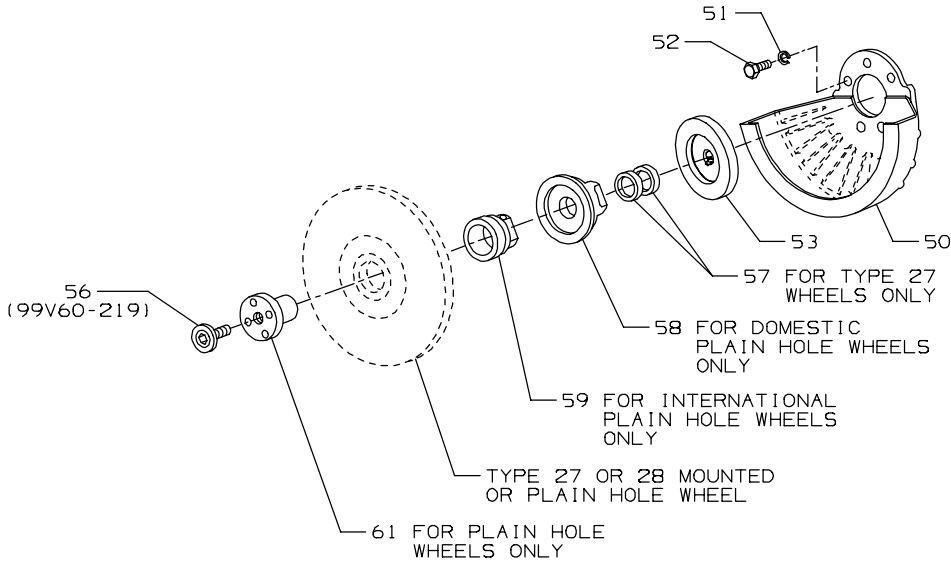

(Dwg. TPA861-5)

**Guards, Flanges and Spacers for 99V Grinders  
Using Cup and Saucer Wheels**

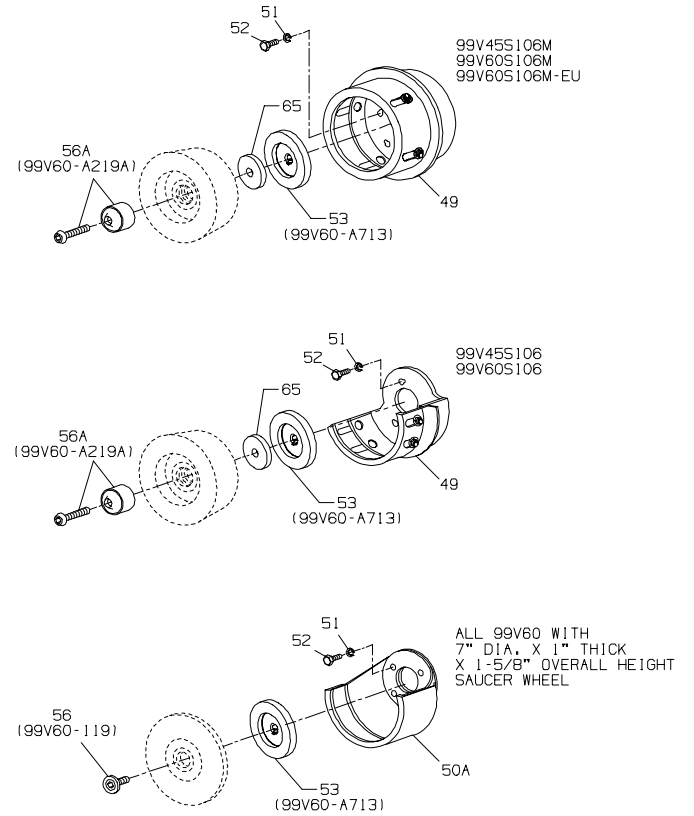

(Dwg. TPA862-3)

**⚠ WARNING**

Never operate the Grinder without the Wheel Retaining Screw (56 or 56A) installed in its proper place in the end of the arbor. Always securely tighten the Wheel Retaining Screw before operating the Grinder.

## MAINTENANCE SECTION

### WARNING

Always wear eye protection when operating or performing maintenance on this tool.

Always turn off the air supply and disconnect the air supply hose before installing, removing or adjusting any accessory on this tool, or before performing any maintenance on this tool.

### LUBRICATION

Each time a Series 99V Vertical Air Grinder is disassembled for maintenance and repair or replacement of parts, lubricate the tool as follows:

1. Inject approximately 1.5 cc of Ingersoll-Rand No. 50 Oil into the Inlet Bushing (5) after assembly. **For models with a built-in oiler**, fill the chamber of the Oiler Assembly (23). After each eight hours of operation, replenish the oil supply.
2. If the Grinder is used in an extremely dirty environment, **once each week or after each forty hours of operation**, pour a liberal amount of a clean, suitable cleaning solution into the slots in the handle. Work the throttle lever vigorously to wash the cleaning solution around, and then pour the solution and accumulated dirt from the handle. Repeat this process until the cleaning solution is clean when it comes out of the handle. Immediately after flushing with the cleaning solution, inject a liberal amount of Ingersoll-Rand No. 50 Oil in the slots and again work the throttle lever vigorously to lubricate the cleaned parts.

### OILER ADJUSTMENT

#### (for models with built-in oiler)

The built-in lubricator has been properly adjusted at the factory. If the oiler felts are clogged and must be replaced, proceed as follows:

1. Remove the grinding wheel. Remove the Cylinder Case Screws (52), the Lock Washers (51), the Cylinder Case Gasket (48), the two Motor Clamp Washers (47) and the Guard.
2. With a thin blade screwdriver, remove the Oiler Adjusting Screw (25) from the Oiler Assembly (23).
3. Using tweezers or a piece of bent wire, remove the Oiler Felts (24) and install new ones.
4. Replace the Oiler Adjusting Screw, installing it slightly below flush.

### DISASSEMBLY

#### General Instructions

1. Do not disassemble the tool any further than necessary to replace or repair damaged parts.
2. Whenever grasping a tool or a part in a vise, always use leather-covered or copper-covered vise jaws to protect the surface of the part and help prevent distortion. This is particularly true of threaded members and housings.
3. Do not remove any part which is a press fit in or on a subassembly unless the removal of that part is necessary for repairs or replacement.
4. Do not disassemble the tool unless you have a complete set of new gaskets and O-rings for replacements.

#### Disassembly of the Motor

1. Grasp the Dead Handle (27) of the Grinder in leather-covered or copper-covered vise jaws, Guard up.
2. Remove the Cylinder Case Screws (52), the Lock Washers (51), the Cylinder Case Gasket (48), the two Motor Clamp Washers (47) and the Guard.
3. Grasp the Arbor (29) in the vise and lift the Cylinder Case to expose the motor.
4. Remove the Exhaust Silencer (39).
5. **For models with a built-in oiler**, take the tool from the vise and dump the oil from its reservoir. The Oiler Assembly (23) can be pulled from the Cylinder Case, if necessary.

### CAUTION

Use only the special No. 99V60-950 Controller Wrench for removing the Controller Assembly. Do not attempt to disassemble the Controller. It is available only as a unit and is guaranteed for the life of the tool if it is not abused.

### NOTICE

The Controller Assembly (42) has a left-hand thread and the Controller Nut (46) has a right-hand thread.

6. Remove the Controller Nut and unscrew the Controller Assembly (42).
7. Lift off the Rear End Plate (40) and Rotor Bearing Seal.
8. Lift off the Cylinder (36).
9. Remove the Vanes (35).
10. Withdraw the Rotor (34) followed by the Rotor Key (33).
11. Lift off the Front End Plate (31).
12. If the Front Rotor Bearing (30) is to be replaced, press it and the Arbor from the Front End Plate. Press off the Bearing from the Arbor.

## MAINTENANCE SECTION

13. Set the Controller on blocks in an arbor press. Using a round piece of metal fitting the inner race of the Rear Rotor Bearing, press off the Rear Rotor Bearing Cage (45).
14. Insert the Controller into the 99V60–A952 Bearing Clamp and tighten the nut on the fixture. Insert the 99V60–A951 Seal Pressing Tool in the center and press off the Controller. Release the clamp.

### Disassembly of the Throttle and Inlet for Models without a built-in oiler

1. Place the Cylinder Case in the vise to remove the Inlet Bushing (5), Inlet Bushing Screen (5A) and the Throttle Valve Spring (6). The Bushing has an interference thread and is tightly fit.
2. Drive out the Throttle Lever Pin (14) to release the Lever Assembly (15).
3. Using a 3/32" hex wrench, reach inside the handle and remove the Valve Seat Screw (13) from the Throttle Valve Seat Support Assembly (7).
4. Thread a No. 8–32 screw about 5" (127 mm) long into the throttle valve seat support in place of the removed valve seat screw. A piece of 5/32" welding rod can be threaded on one end to serve the same purpose.
5. Grasp the protruding end of the screw in a vise, and while tapping lightly on the housing or handle with a plastic hammer, pull on the housing or handle to withdraw the throttle parts.
6. The Air Strainer Screen (8) can now be removed and cleaned.

### Disassembly of the Throttle and Inlet for Models with a built-in oiler

1. Place the Cylinder Case in the vise to remove the Inlet Bushing (5) and Inlet Bushing Screen (5A).
2. Drive out the Throttle Lever Pin (14) to release the Lever Assembly (15).
3. Remove the Throttle Valve Spring (6) and release the Throttle Valve (2) by tapping the end of the handle with a soft hammer.
4. Bend a piece of 1/8" diameter rod as shown in Drawing TPD548. Insert this "puller" into the screw head and withdraw the Throttle Valve Seat Support Assembly (7) by hand, or with lever-wrench pliers, using a prying action if needed.

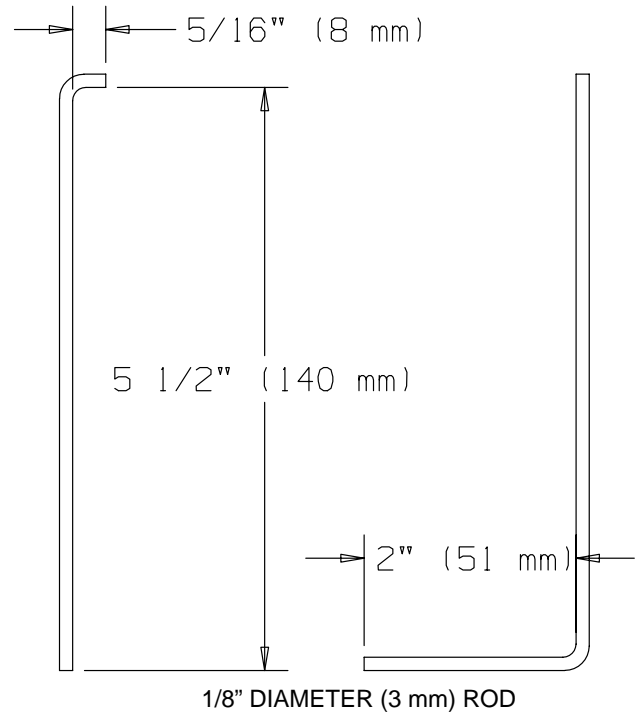

(Dwg. TPD548)

5. Remove the Valve Seat Screw (13), Valve Seat (10), Valve Seat Washer (11), Lock Washer (12) and Valve Seat Cap (9). The Air Strainer Screen (8) may now be removed.

## ASSEMBLY

### General Instructions

1. Always press on the **inner** ring of a ball-type bearing when installing the bearing on a shaft.
2. Always press on the **outer** ring of a ball-type bearing when pressing the bearing into a bearing recess.
3. Whenever grasping a tool or part in a vise, always use leather-covered or copper-covered vise jaws. Take extra care with threaded parts or housings.
4. Always clean every part and wipe every part with a thin film of oil before installation.
5. Apply a film of O-ring lubricant to all O-rings before final assembly.
6. Check every bearing for roughness. If an open bearing must be cleaned, wash it thoroughly in a suitable cleaning solution and dry with a clean cloth. **Sealed or shielded bearing should never be cleaned.** Work grease thoroughly into every open bearing before installation.

## MAINTENANCE SECTION

### Assembly of the Throttle and Inlet

#### NOTICE

**Thoroughly clean and lubricate all Throttle Valve components before assembling the tool. Lubricate with Ingersoll-Rand Light Oil No. 10.**

1. Grasp the Dead Handle in leather-covered or copper-covered vise jaws with the live air handle upward.
2. Assemble the Valve Seat Support parts.
3. Insert the Support Assembly (7) into the handle, large diameter first. Locate a punch on the flat of the screw head and tap it with a hammer until the Assembly is firmly seated.
4. Apply O-ring lubricant to the Seals (3) or (3 and 4). Fit the seals to the Throttle Valve (2) and push the assembly, small diameter first, into the handle until it seats firmly.

#### NOTICE

**If Lever Assembly being serviced does not have the window-type lever, install a complete new Lever Assembly.**

5. Assemble the Lever Assembly (15) as illustrated below.

### Locking Lever Assembly

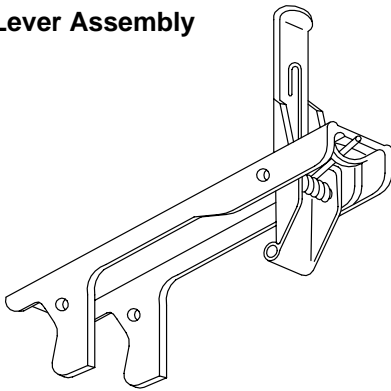

(Dwg. TPD563)

6. Align the holes in the Lever Assembly with the slots in the Cylinder Case. With a soft face hammer, tap the Throttle Lever Pin (14) through the Lever Assembly. File off any sharp edges. Operate the mechanism internally by hand to assure operation.
7. Insert the Throttle Valve Spring (6), small end first.
8. Clean the face of the Inlet Bushing (5) and the Inlet Bushing Screen (5A) using a suitable cleaning solution, and dry them. Insert the screen and bushing in the end of the Cylinder Case by grasping the flats with a wrench. Tighten the Bushing between 35 and 45 ft-lb. (47 and 61 Nm) torque.

### Assembly of the Motor

1. Using an arbor press against the inner race of the bearing, install the Front Rotor Bearing (30) onto the Arbor (29).
2. Inspect the Front End Plate (31) for nicks or burrs. Press the arbor bearing into the front end plate.
3. With the Arbor held firmly in vise jaws, place the Rotor Key (33) in the slot of the Rotor (34).

#### NOTICE

**The Rotor should slip fit over the Arbor. If tightness is detected, lightly polish one long side of the Key using fine emery cloth on a hard, flat surface. Replace the Key with the polished side toward the Arbor.**

4. The Rotor is counter-bored on one end. Place that end over the Arbor. Apply a light film of Ingersoll-Rand No. 50 Oil to each Vane (35) and insert one vane, straight end out, into each slot in the Rotor. If any new Vanes are required, replace the entire set.
5. Place the Cylinder Assembly (36) over the Rotor matching the End Plate Dowel (short dowel) (37) to the alignment hole in the Front End Plate (31).

#### NOTICE

**If the Controller Assembly (42) needs to be replaced, you must also replace the Rotor Bearing Seal Assembly (43) which consists of the Rear Rotor Bearing and Rotor Bearing Seal. If either the Rear Rotor Bearing or Rotor Bearing Seal needs to be replaced, both must be replaced with a new Bearing and Seal. Do not mix old and new parts.**

6. Clean the Rotor Bearing Seal (43) and measure the outside diameter and large inside diameter. If the outside diameter is worn to 1.1764" (29.88/mm) or smaller, and/or the large inside diameter is worn to 0.9103: (23.122 mm) or larger, install a new Rotor Bearing Seal.

#### NOTICE

**Take all measurements 90 degrees to the left of the dowel hole when facing the hub side of the Seal.**

7. Align the Rear End Plate (40), cavity and pin up, with the larger hole in the Rotor Bearing Seal.
8. Press the Rear Rotor Bearing onto the Controller Assembly (42). Press the Controller Assembly into the Bearing Cage (45) to within 1/8" of seating.

## MAINTENANCE SECTION

9. Apply a film of light grease to the inside diameter and outside diameter of the Rotor Bearing Seal and align the Seal with both cylinder dowel pins.

### NOTICE

Use only the special No. 99V60–950 Controller Wrench for installing the Controller Assembly. Tighten to 10 ft–lb (13.6 Nm) torque.

### ⚠ WARNING

Tighten the Controller to 14 to 16 ft–lb (19.0 to 21.7 Nm) torque. Do not exceed 16 ft–lb. The Controller may be damaged if this torque is exceeded. Always check the free speed of a Grinder after it has been reassembled and before it is put back into service. Refer to the Test and Inspection Procedure.

Never use a Grinder which runs in excess of the maximum speed listed in the Test and Inspection Procedure.

### NOTICE

The Controller has a left–hand thread.

10. Slip the Controller Assembly over the arbor aligning the Dowel Pin hole with the Cylinder Dowel (38).
11. Apply the Controller Retaining Nut (46) and tighten to 6ft–lb (8.1 Nm) torque for 99V85 Models, 9 ft–lb (12.2 Nm) for all other models. Lightly tap both ends of the Arbor (29). The Arbor and Rotor (34) must turn freely when manually rotated, and the Cylinder (36) must have some play between the end plates.
12. Hold the Cylinder Case in a vise with the motor bore upward by gently clamping the Dead Handle (27).
13. Dampen the Rear End Plate Gasket (41) with Ingersoll–Rand No. 50 Oil, align it with the hole in the motor seat and place the Gasket in the Cylinder Case.
14. Center the long boss on the face of the Front End Plate (31) with the alignment mark on the face of the Cylinder Case and insert the motor into the bore approximately 1/2” (13 mm).
15. Wrap the Exhaust Silencer (39) around the Cylinder with the felt end over the exhaust ports in the Cylinder.
16. Slide the motor into the motor bore.

### NOTICE

It may be necessary to slightly rotate the motor to fully seat it in the Cylinder Case bore.

17. Insert the two Motor Clamp Washers (47), beveled side down.
18. **For models with built–in oilers**, if the Oiler Assembly (23) was removed from the Cylinder Case, apply the Oiler Body Seal (26) to the lip of the Oiler Assembly (23), insert the Oiler Felts (24) and tighten the Oiler Adjusting Screw (25). Seat the assembly in the cavity of the Cylinder Case and fill the Oiler with the recommended oil.
19. Apply the Cylinder Case Gasket (48), the proper Guard (49 or 50), the Cylinder Case Screw Lock Washers (51) and the four Screws (52). Slightly tighten opposite screws, make sure the arbor is free and then tighten all screws to 14 ft–lb (19 Nm) torque.
20. Again, make certain the Arbor is free.
21. The Dead Handle (27) can be adjusted to two positions.  
**For models without a built–in oiler**, insert a 5” (127 mm) long 3/16” hex wrench into the elongated slot in the end of the Dead Handle and loosen the screw securing the Handle to the Cylinder Case. Rotate the Handle 180° and tighten the screw to 18 ft–lb. (24.4 Nm) torque.  
**For models with a built–in oiler**, loosen the Dead Handle Screw (28), change the position of the Dead Handle and tighten the Screw to 9 ft–lb. (12.2 Nm) torque.

## MAINTENANCE SECTION

### TEST AND INSPECTION PROCEDURE



**Disconnect the Grinder from the air supply hose or shut off air to the tool before proceeding with the test and inspection procedure.**

Run the performance tests at 90 psig (6.2 bar/620 kPa) air pressure at the inlet of the tool with an eight foot (2.44 m) length of 3/4" (19 mm) diameter air supply hose.

1. Without a wheel on the tool, operate the Grinder with the Throttle Lever fully depressed and check the free speed by applying a hand-held tachometer to the spindle end. The minimum and maximum allowable free speeds are as follows:

Model	Stamped	Free Speed, rpm	
		Minimum	Maximum
99V45	4500	4 300	4 550
99V60	6000	5 650	6 050
99V77	7700	7 250	7 750
99V85	8500	7 950	8 550

2. Test the Grinder motor for power to determine these minimum performance levels. The Throttle Lever must not be actuated repeatedly during the test. Depress the Lever and hold it in the open position until the test is complete.

Model	Torque		Speed rpm
	ft-lb	Nm	
99V45	3.80	5.15	3 300
99V60	3.50	4.75	4 400
99V77	3.10	4.20	5 500
99V85	3.10	4.20	5 500

3. There must be no objectionable leaks in any non-exhaust area. The Throttle must not leak when it is closed.
4. There must be no leaks past the closed Throttle that will run the motor.
5. The Grinder must start smoothly when the Throttle Lever is depressed and must shut off completely when the Throttle Lever is released.
6. The Grinder must be equipped with a spring-loaded window style Lever Lock (15). The Lever Lock must return to the locked position when the Throttle Lever is released.
7. The tool must run smoothly without noticeable vibration or unusual sound.
8. The Arbor (27) must turn freely with no evidence of brinelled bearings.
9. The Threads on the arbor must be free of nicks and damage.
10. The Nameplate must be legible, in place and securely fastened. Make replacement if necessary.



## MAINTENANCE SECTION

### TROUBLESHOOTING GUIDE

Trouble	Probable Cause	Solution
Low power or low free speed	Low air pressure at the Inlet	Check the air pressure at the Inlet. The pressure must not exceed 90 psig (6.2 bar/620 kPa).
	Plugged Screen	Clean the Screen in a clean, suitable, cleaning solution. If it cannot be cleaned, replace it.  <b>⚠ WARNING</b> <b>Never operate a Grinder without an Inlet Screen. Ingestion of dirt into the Grinder can, in some cases, cause an unsafe condition.</b>
	Worn or broken Vanes	Replace a <b>complete</b> set of Vanes.
	Worn or broken Cylinder	Replace the Cylinder if it is worn or broken or if the bore is scored or wavy.
	Improper lubrication or dirt build-up in the motor	Lubricate the Grinder as instructed in <b>LUBRICATION SPECIFICATION</b> . If lubrication does not result in satisfactory operation, disassemble the motor and inspect and clean all parts.
Rough operation	Worn or broken Rear Rotor Bearing or Front Rotor Bearing	Examine each Bearing. Replace the Rear Rotor Bearing Seal Assembly if worn or damaged or replace the Front Rotor Bearing.
	Worn Rotor Key	Replace the Key. Check the Arbor and Rotor for key slot wear and replace if necessary.
	Bent Arbor	Mount the Arbor on centers. Check the bearing diameter runout with an indicator. Replace the Arbor if runout exceeds 0.002" Total Indicator Reading.
Scoring	Improper assembly	Make certain that all motor parts are properly aligned prior to clamping the motor assembly.
	Rotor Bearing Seal misalignment	Loosen the Cylinder Case Screws. Rotate the Spindle by hand to align the seal. Retighten the Screws to 14 ft-lb (19 Nm) torque. The Spindle must rotate freely.
Air leaks	Worn Valve Seat or Valve Seat Washer	Replace worn parts.
	Worn Throttle Valve Seals	Replace both Seals.
	Worn Cylinder Case Gasket	Replace the Gasket.
	Oiler Plug and Oiler Plug Washer not tight	Tighten the Plug. If the problem persists, replace the Washer.
	Distorted face on Cylinder Case	Polish lightly to remove high spots. If the Grinder has been dropped and the Cylinder Case is damaged, replace with a new Cylinder Case Assembly.

### NOTICE

**SAVE THESE INSTRUCTIONS. DO NOT DESTROY.**



