

www.deltaregis.com



**PRECISION
PERFORMANCE
PRODUCTIVITY**

DELTA REGIS
Tools Inc.

DELTA REGIS
Tools Inc.

DELTA REGIS
Tools Inc.

■ SCREW FEEDERS ■ ASSEMBLY TOOLS ■ TORQUE TESTERS ■ TOOL SUPPORTS ■ SCREW FEEDERS ■ ASSEMBLY TOOLS ■ TORQUE TESTERS



Delta Regis products are warranted for one year from the date of purchase against defects in material and workmanship. In addition, DC premium brushless screwdrivers are warranted for two years and DC brushless motors are warranted for three years from the date of purchase against defects in material and workmanship. This warranty does not cover damage due to transportation, abuse, misuse, alteration, or improper service. Items subject to wear during normal use (such as tool cables, carbon brushes, driver bits, etc) are considered maintenance items and are not normally covered by this warranty, unless deemed to be defective upon our further evaluation.

Our sole remedy is to repair or replace (at our discretion) any unit found to be defective due to defects in material or workmanship. It is the responsibility of the user to return any product thought to be defective, freight prepaid, to our warehouse for inspection and evaluation.

There is no warranty of merchantability or fitness of purpose. In no event will Delta Regis Tools, Inc. be liable for business interruptions, loss of profits, harm, injury, damage, personal injury, cost of delay, or any other special, indirect, incidental, or consequential losses, costs, or damages.

Efforts have been made to ensure the accuracy of the information and specifications in this catalog. Delta Regis Tools reserves the right to correct or change any specifications found herein without further notification.

Please contact us if you have any questions, concerns, or would like to discuss the details of an application. We are available to assist in any way that we can.

SCREWDRIVERS, CONTROLLERS

			Page
	Premium Brushless 12VDC Shut-Off Clutch w/Controller	.01-.34 Nm (.07-3 in-lb)	7
	Premium Brushless 32VDC Shut-Off Clutch w/Controllers	.02-1.8 Nm (.2-16 in-lb)	8 - 11
	Premium Brushless 40VDC Shut-Off Clutch w/Controller	1-18 Nm (9-159 in-lb)	12 - 14
	Premium Brushless with Built-In Counter	.15-4.9 Nm (1.3-43 in-lb)	15
	Count & Verify Controller for 32/40VDC Brushless	with I/O interface	16 - 17
	Standard Duty 32VDC Shut-Off Clutch w/Controller	.02-4.6 Nm (0.2-41 in-lb)	18 - 19
	Standard Duty Plug-in 120V-220VAC Shut-Off Clutch	.2-4.4 Nm (1.8-39 in-lb)	20 - 21
	Economy Plug-In 120VAC Slip (Ratchet) Clutch	.05-4.4 Nm (0.5-39 in-lb)	22
	Manual Torque Screwdrivers, Adjustable and Preset	.15-6 Nm (1.3-50 in-lb)	23

TOOL SUPPORTS

			Page
	ERGO-12 / 30 Telescopic Torque Reaction Arm	12 or 30 Nm models	26
	DR90-20004 Economy Torque Arm	adjust. spring assist	26
	ERGO-25 Precision Parallel Torque Arm	adjust. pneumatic assist	27
	DR90-30001 Bench Mount Tool Stand	60 cm (24 in) reach	28
	Tool Balancers, 0.23-2.2 kg (0.5-5 lb) capacity	1.8 m (6 ft) travel	28
	ERGO-SYS Tool Support System	stand with reaction arm	29

TORQUE TESTERS, SCREW FEEDERS, ACCESSORIES

			Page
	DRFF-520 Adjustable Rail Screw Feeder	for 1-5mm thread dia.	24
	DRBT Bench Torque Tester w/rundown joints	10 Nm (90 in-lb) cap.	25
	Screwdriver Vacuum Pickup Attachment	for non-ferrous apps.	30
	Screwdriver Bits and Bit Holders	details on website	31

INFORMATION

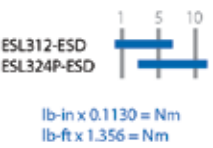
			Page
 <p>ESL312-ESD ESL324P-ESD</p> <p>1 5 10</p> <p>lb-in x 0.1130 = Nm lb-ft x 1.356 = Nm</p>	Electric Screwdriver Selection Chart	quick selection guide	4 - 5
	Electric Screwdriver Features	driver overview	6
	Torque Conversion	reference info	31
	Warranty, Repair	see opposite page	-

SCREWDRIVER SELECTION GUIDELINES

Know your assembly requirements

With the endless range of applications for installing threaded fasteners, proper selection of a screwdriver begins with knowing the details of the job that needs to be performed by the driver.

Torque - What is the required torque to properly install the fastener? This torque value is determined through the engineering and testing of the product being assembled and not something that we can provide for you. How critical is the final torque value?

Prevailing Torque - Is the fastener running down freely into a threaded hole, or is it self-tapping? Does the fastener have thread-locking compound or a locknut? Any prevailing torque must be lower than final torque.

Joint Type - Once the fastener initially seats, is there extended rotation of the screwdriver due to soft gaskets, spring washers, or other compression in the assembled joint?

Speed and Direction - Is the fastener installation speed restricted by materials (eg plastics) or other design criteria? Will the screwdriver run primarily in the forward (CW) direction, or does the application require frequent switching between forward and reverse?

Duty Cycle - What is the estimated time to run-down a fastener? How many fasteners are installed per minute? How many hours will the tool be running per day? Is there prevailing torque during run-down?

Determine the appropriate series and model number

Based on the application's torque (and speed) requirements, the quick reference chart on the previous page indicates possible choices in the Delta Regis product line. In many cases, you will find that several models of screwdriver offer the required torque output. Try to select models where the required torque falls into the middle portion of the screwdriver's range. The chart is sub-divided by series of screwdriver. Final selection can be determined by consideration of the series attributes outlined below - feel free to contact us for assistance.

DC Premium Brushless (12V/32V/40V) - The DC brushless models offer the best performance for production applications. Clean running, maintenance-free brushless DC motors allow for higher duty cycles than brush motor tools. Premium low voltage DC drivers are available with ESD-safe housings and various control options. Standard controllers have Hi/Lo speed selection, optional controllers available for slow start, I/O and counting with rundown verification. All brushless tools come with precise shut-off clutch for excellent repeatability.

DC Brush (32V) - The DC brush-type screwdriver is the predecessor to our premium brushless models. The series offers similar controller options and precise shut-off clutch in a tool with a brush-type DC motor. It has a lower duty cycle than the brushless (recommended max is 25%) and requires brush replacement as part of regular maintenance.

AC Direct Plug-In, Shut-off Clutch (120V) - The convenience of direct AC plug-in with a precise shut-off clutch. These single speed screwdrivers are powered by higher voltage DC brush motors. No control options or I/O are available. ESD-safe housings are not available on the direct plug-in series. AC tools are generally slightly larger than their DC counterparts.

AC Direct Plug-In, Ratchet Clutch (120V) - Economical tool with brush motor and ratcheting clutch for general industrial box-build and self-tapping screw applications.

Selection Guide

Model No.	RPM	Page	Torque Range - Nm (in-lb)																		
			0	1 (8.8)	2 (16.7)	3 (26.5)	4 (35.4)	5 (44.2)	7.5 (66.4)	10 (88.5)	15 (132)										
12VDC Shut-off Premium Brushless			7																		
ESL210	1000 / 700																				
ESL210S	280 / 200																				
ESL211	1000 / 700																				
ESL211S	280 / 200																				
32VDC Shut-off (Brush type)			18-19																		
ESL310	1000 / 600																				
ESL311	1000 / 600																				
ESL312	670 / 400																				
ESL323 / 323P	1000 / 600																				
ESL324 / 324P	1000 / 600																				
ESL327 / 327P	750 / 450																				
ESL328 / 328P	530 / 300																				
ESL329 / 329P	530 / 300																				
32VDC Shut-off Premium Brushless			8-11																		
CESL610	1000 / 700																				
CESL610S	500 / 350																				
CESL611	1000 / 700																				
CESL612	1000 / 700																				
(I)CESL623 / 623P	1000 / 700																				
(I)CESL623F / 623PF	2000																				
(I)CESL624 / 624P	1000 / 700																				
40VDC Shut-off Premium Brushless			12-15																		
(IC)ESL628 / 628P	1000 / 750																				
(IC)ESL628F / 628PF	2000																				
(IC)ESL629 / 629P	1000 / 750																				
40VDC Shut-off Fixtured / Pistol Grip			12-15																		
ESL635(P)M / ESP635	1000 / 750																				
ESL645(P)M / ESP645	800 / 600																				
ESL655(P)M / ESP655	550 / 410																				
ESL665(P)M / ESP665	350 / 260																				
120/220VAC Shut-off Direct Plug-in			20-21																		
ESL300 / 300P	1000																				
ESL301 / 301P	1000																				
ESL302 / 302P	525																				
ESL383E / 383PE	1000																				
ESL383FE / 383PFE	1900																				
ESL384(F)E / 384P(F)E	700 (1000)																				
ESL385E / 385PE	500																				
120VAC Slip Clutch Direct Plug-in			22																		
ESL500	1000																				
ESL501	1000																				
ESL502	830																				
ESL503	550																				

Our drivers are designed with operator ergonomics in mind. Most models feature a cushioned grip for operator comfort. Our 12V, 32V and 40VDC Screwdrivers are available with ESD-Safe housings for assembling sensitive components. Other features include:



Suspension bail allows for hanging tool from tool balancer for improved ergonomics and tool life.



Stepless external torque adjustment includes scale (0-8) for reference purposes (scale does not indicate actual torque value).



Quick change bit holder accepts industrial screwdriver bits:
ESL210-211, 610-612: 4mm round bits
All other models: 1/4" hex power bits



Torque Repeatability - Delta Regis Electric Drivers utilize precise clutches for repeatable performance. The factory target values are:
32VDC / 120VAC Shut-off Clutch: +/- 3%
12VDC / 40VDC / 120VAC Slip Clutch: +/- 5%

Please note that actual repeatability is joint dependent. It will vary based on factors such as joint type and consistency, lubrication, speed, operator input, and test equipment.



All models have a forward/reverse switch located conveniently for thumb operation. Tools with brush type motors have externally replaceable carbon brushes accessible via removal of a slotted brush cap.



A torque lock sleeve can be installed in place of the standard front housing nut to cover the torque adjustment and prevent accidental changes. 12VDC and 32VDC brushless models include a torque lock sleeve.

ESL2 SERIES MINI BRUSHLESS, SHUT-OFF CLUTCH 12VDC Electric Screwdrivers

The Delta Regis ESL2 Series Miniature Shut-Off Screwdriver provides excellent low torque repeatability in a small package for precise installation of small screws. The screwdriver's brushless 12VDC motor ensures durability and low maintenance. Each tool includes a 2m cable to connect to the required BECT200 Controller.

- Compact size designed for installing miniature fasteners. Ideal for assembly of cell phones and other small electronics.
- Precise shut-off clutch provides excellent repeatability
- Torque range of 0.07 - 3.08 in-lbs (0.01 - 0.34 Nm)
- Low RPM models available for slow-speed applications
- ESD safe tool housing is standard (non-ESD available)
- Lever start, top-mounted reverse button
- 12VDC brushless motor requires no maintenance
- 2M (6.4 ft) tool cable and torque lock sleeve included
- Bit holder accepts 4mm round winged bits (2 included)
- Tool is CE/RoHS compliant; Controller is CE/RoHS/ETL



BECT200
HI/LO SPEED CONTROLLER



TOP-MOUNTED REVERSE BUTTON
AND DETACHABLE 2m TOOL CABLE



DR80-10129E
TORQUE LOCK SLEEVE
INCLUDED WITH TOOL



INCLUDES 2 BITS:
ESL210 - PH#00, #0
ESL211 - PH#0, #1



4mm BIT DRIVE FOR
MINIMAL RUN-OUT

12VDC Brushless Screwdrivers & Controllers						
Model No. with Controller ^(1,2)	Range In.Lbs	Range Nm	Speed (RPM) Hi / Lo	Length in / mm	Grip Dia. in / mm	Weight lbs / g
ESL210-ESD / BECT200	0.07 - 1.32	0.01 - 0.147	1000 / 700	6.5 / 165	0.9 / 23	0.4 / 170
ESL210S-ESD / BECT200	0.07 - 1.32	0.01 - 0.147	280 / 200			
ESL211-ESD / BECT200	0.44 - 3.08	0.05 - 0.343	1000 / 700			
ESL211S-ESD / BECT200	0.44 - 3.08	0.05 - 0.343	280 / 200			

⁽¹⁾ Screwdriver and Controller are packaged and sold as a set. Above dimensions are for the screwdriver only.

⁽²⁾ Controller includes standard North American power cord. Add suffix 'E' for EU cord, suffix 'UK' for UK cord.

BECT200 Controller Specifications		
Input 100-240VAC, 50/60hz, 1A ; Output 12/9VDC, 30W	105 x 52 x 31 mm	0.3 / 140

CESL6 SERIES PREMIUM BRUSHLESS, SHUT-OFF CLUTCH 32VDC Electric Screwdrivers

The Delta Regis CESL6 Series Premium Brushless Screwdrivers provide the ultimate combination of ergonomics, precision, performance and environmental cleanliness to the installation of fasteners. The quiet, brushless DC motor does not create the carbon dust generated by the brushes in a conventional DC motor. The motor's low power consumption results in a tool that runs cooler, even under demanding applications.

- Precise Torque Control, Low Torque Reaction.
- Quiet, Brushless DC motor means no carbon dust.
- Compact body design results in exceptional manouverability and operator comfort.
- Less heat build-up and higher duty cycle capabilities than conventional brush motors. 3 year motor warranty.
- 32V DC models feature ESD safe housings.
- Each screwdriver includes an accessory torque lock sleeve and a 6-pin, 2m long cable for connecting to a compatible brushless controller (controller req'd - sold separately).
- CE, RoHS Compliant.



The CESL6 Series 32V DC Brushless Screwdriver can be used with either the standard BECT620C(IC) Hi/Lo Speed Controller or with our FASTEN/COUNT/VERIFY Controller for applications requiring batch counting and input/output interface with external equipment. Please see pages 10-11 and 14-15 for further details.

32VDC Brushless Screwdriver Models										
Model No. w/ESD Housing	Model No. without ESD	Start Type	Range (In.Lbs)	Range (Nm)	Speed (RPM) Hi	Speed (RPM) Lo	Driver Bit Type	Length (mm)	Diameter (mm)	Weight (g)
CESL610-ESD	-	Lever	0.2 - 3.1	0.02 - 0.35	1000	700	4mm	185	32	385
CESL610S-ESD	-		0.2 - 3.1	0.02 - 0.35	500	350				
CESL611-ESD	CESL611		0.4 - 6.2	0.05 - 0.69	1000	700				
CESL612-ESD	CESL612		0.9 - 8.7	0.10 - 0.98	1000	700				
CESL610-ESD-HX	-	Lever	0.2 - 3.1	0.02 - 0.35	1000	700	1/4" hex			
CESL610S-ESD-HX	-		0.2 - 3.1	0.02 - 0.35	500	350				
CESL611-ESD-HX	CESL611-HX		0.4 - 6.2	0.05 - 0.69	1000	700				
CESL612-ESD-HX	CESL612-HX		0.9 - 8.7	0.10 - 0.98	1000	700				
CESL623-ESD	CESL623	Lever	1.3 - 10.5	0.15 - 1.18	1000	700	1/4" hex	245	36	520
CESL623F-ESD ⁽¹⁾	CESL623F ⁽¹⁾		1.3 - 10.5	0.15 - 1.18	2000	-				
CESL624-ESD	CESL624		2.6 - 16.5	0.29 - 1.86	1000	700				
CESL623P-ESD	CESL623P	Push	1.3 - 10.5	0.15 - 1.18	1000	700				
CESL623PF-ESD ⁽¹⁾	CESL623PF ⁽¹⁾		1.3 - 10.5	0.15 - 1.18	2000	-				
CESL624P-ESD	CESL624P		2.6 - 16.5	0.29 - 1.86	1000	700				

⁽¹⁾ For high speed 'F' suffix models, use the BECT620IC Controller on Hi Speed setting only.

Accessories

The following 32VDC Controllers are specifically for use with CESL610-624 Brushless Tools. One controller (ordered separately) is required per screwdriver. Select the appropriate controller for your screwdriver model. CE/RoHS/ETL Approved. The BECT620IC is recommended for use with fast tool models CESL623F/PF.

Controllers for 32VDC Brushless Drivers							
Model Number ⁽¹⁾	Outlets	Speeds	Tool Connector	Output	Input	Dimensions L x W x H (mm)	Weight (kg)
BECT620C	1	Hi/Lo	6 pin	32/24V DC	100-240V AC	145 x 60 x 35	0.25
BECT620IC	1	Hi/Lo	6 pin	32/24V DC	100-240V AC	195 x 76 x 56	0.45



⁽¹⁾Part number with North American cordset. For EU cord, add suffix 'E', UK cord add suffix 'UK'.

The ECT6-SSOA-C Control Module allows you to add "Adjustable Slow-Start" and "Output Signal" capability to your Delta Regis CESL6 Brushless Screwdriver. This external control module plugs in-line between the BECT620C/IC controller and a CESL6 Series screwdriver.

Model Number	Use with Controller Model	Slow Start Time	Slow Start Speed	Output Signals Available (Transistor-open collector)	Cable Length	Dimensions (mm)
ECT6-SSOA-C	BECT620(IC)	0.1 ~ 5 sec.	30-100% full spd	Run/Clutch/Reverse	0.3m	58 x 95 x 35

Accessories	Select driver model no. on the right, follow column down the chart; X signifies an appropriate accessory.																		
	CESL610-ESD (-HX)	CESL610S-ESD (-HX)	CESL611-ESD	CESL612-ESD	CESL611 (-HX)	CESL612 (-HX)	CESL623-ESD	CESL623F-ESD	CESL624-ESD	CESL623P-ESD	CESL623PF-ESD	CESL624P-ESD	CESL623	CESL623F	CESL624	CESL623P	CESL623PF	CESL624P	
Torque Lock Sleeve - covers the torque adjusting nut to deter tampering (one included with each driver)																			
DR80-20133C					X														
DR80-20133E (ESD safe)	X		X																
DR80-10134C													X		X		X		X
DR80-10134E (ESD safe)							X	X	X	X									
Pistol Grip Attachment - reconfigures an in-line screwdriver for horizontal fastener installation																			
DR80-PG623/4													X		X				
DR80-PG623/4-ESD							X	X											
DR80-PG623/4P																	X		X
DR80-PG623/4P-ESD									X	X									
Tool Holster - fasten to the edge of a workbench and park the screwdriver when not in use																			
DR80-10136 (w/ lock sleeve)							X	X	X	X	X	X	X	X	X	X	X	X	X
DR80-20136 (no lock sleeve)							X	X	X	X	X	X	X	X	X	X	X	X	X
DR80-20141	X		X		X														
Angle Head Attachment - 90 degree angle attachment for accessing tight spaces (lever start tools only)																			
DR80-10161A							X	X					X		X				
Cable Assemblies - for use with all 32VDC CESL6 Screwdrivers																			
DR96-66002	2m (6.5 ft), 6 pin, Standard Cable (included with each screwdriver)																		
DR96-66003	3m (9.8 ft), 6 pin, Optional Long Cable																		
DR96-66003/C	3m (9.8 ft), 6 pin, Coiled Cable with 0.4m whip ends																		

For other accessories including balancers, support arms, screw feeders, and torque testers, see pgs 24-30

COUNTING CONTROLLER - 32V BRUSHLESS CESL6 DRIVERS

Fasten | Count | Verify

Add functionality and error-proofing to your CESL6 Series Screwdriver with the BECT626-SSO Counting Controller. This controller offers a host of options including Slow Start, Batch Counting, and OK/NG Rundown Indication based on the screwdriving cycle occurring within a predefined time window. An externally accessible I/O connection provides the user with a signal interface. Outputs (24VDC, 10mA max) are available for rundown OK, rundown NG, and batch complete. External switches may be wired to the input for remote enable (part in position) and remote clear (reset batch count).

- Selectable **Slow Start** Speed and Time
- Large LED Display of Screw Count Values
- Externally Accessible **I/O Connections**
- **Programmable Batch Counting** with Audible Buzzer indicating batch complete
- **Programmable Time Window** for comparison with actual fastening cycle time - LED's indicate **OK/NG** rundown cycle
- Works with all CESL6 Series 32VDC Screwdrivers
- ETL / CE / RoHS Compliant



Counting Controller Models & Specifications

Model Number	Outlets	Speeds	Approvals	Output	Input	Dimensions L x W x H (mm)	Weight (kg)	Use only with Driver Models
BECT626-SSO	1	Hi/Lo	CE/RoHS/ETL	32/20V DC, 60VA	100-240V AC	150 x 130 x 48	0.9	CESL6 Series

Power supply shipped with standard North American cordset. For EU cord, add suffix 'E'; for UK cord, add suffix 'UK'.

Features	
Slow Start Time Adjustment	0 - 9.9 sec
Slow Start Speed Adjustment	30 - 100%
Count (per batch)	1 - 99
Time Window Setting Range (min/max)	0 - 9.9 sec
Audible Alert (selectable)	Good/NG/Batch OK

Inputs
1. Remote Enable
2. Clear (Reset) Batch Count

Sinking Outputs (24VDC, 10mA max)
1. Rundown OK
2. Rundown NG
3. Batch Complete

Inputs require an external switch (dry contact) only. A 32/20 VDC voltage supply is available to power the output circuit, if required.

BECT626-SSO Controller Overview

Parameters are set-up on the BECT6-SSO using the four button keypad and LED display panel. A simple program loop provides access to settings for slow start speed and time, batch count quantity, and min/max allowable rundown times. During normal operation, the large two-digit display shows the current screw count value and also provides visual LED indication of whether the rundown was Good or No Good based on the time window parameters that are programmed into the controller by the user.

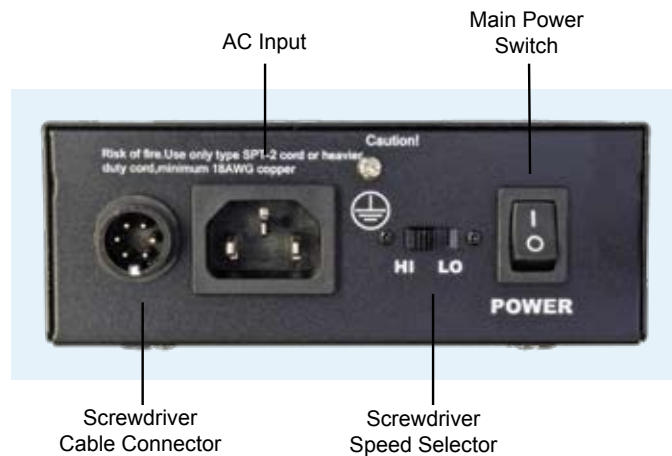
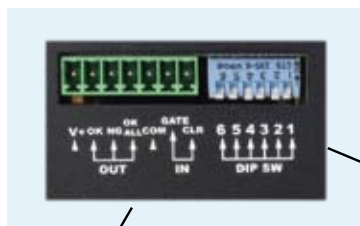
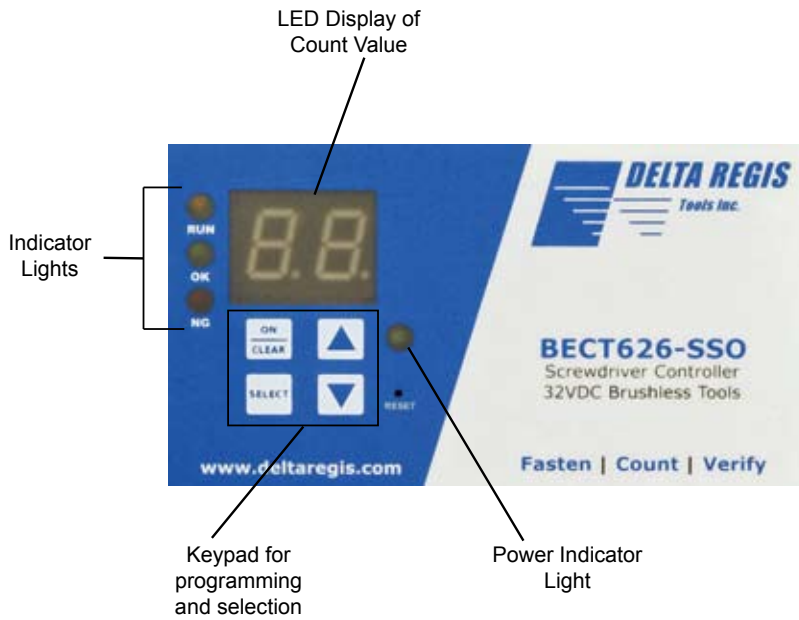

Input / Output Connections:
32/20 VDC (hi/lo) supply (if req'd to power external circuit)
OK / NG / OK ALL (sinking outputs - 24VDC, 10mA max)
ENABLE input (requires normally closed switch contact)
CLEAR input (requires normally open switch contact)
COM - 0VDC (supply, input and sinking output common)

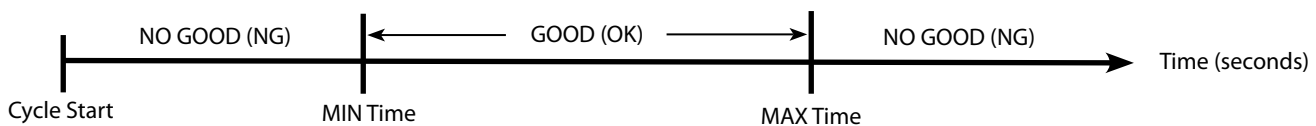

If the fastening cycle completes (clutch trips) within the programmed time window, the rundown cycle will be accepted as GOOD (OK) and the batch count will increment.

HIGH TORQUE PREMIUM BRUSHLESS, SHUT-OFF CLUTCH 40VDC Electric Screwdrivers

Delta Regis 40VDC Premium Brushless Screwdrivers pack the performance to satisfy demanding assembly applications. With torque capabilities to 18 Nm and brushless motor technology that withstands higher duty cycles, these drivers are ready to perform on production lines typically dependent on pneumatic tools. As with all Delta Regis Shut-off Clutch Screwdrivers, excellent torque repeatability is the fundamental building block that defines these models. A host of screwdriver configurations, accessories, and control options are available to make the 40VDC Series an ideal choice for production assembly across a wide range of industries.



ALL ESL628/629 INLINE DRIVERS
INCLUDE A PISTOL GRIP ATTACHMENT
AND TORQUE LOCK SLEEVE.

ESL628/629 Handheld Inline Drivers have powerful brushless motors to handle demanding applications. Fast versions are available to speed-up production lines that require installation of long fasteners.

ESL6 Handheld Inline Drivers					
Model Number	Start Type	Range (In.Lbs)	Range (Nm)	Speed (RPM)	Drive Type
Inline Body Style, Handheld ⁽¹⁾					
ESL628	Lever	8.9 - 26.0	0.98 - 2.94	1000	1/4" hex
ESL628F	Lever	8.9 - 26.0	0.98 - 2.94	2000	1/4" hex
ESL628P	Push	8.9 - 26.0	0.98 - 2.94	1000	1/4" hex
ESL628PF	Push	8.9 - 26.0	0.98 - 2.94	2000	1/4" hex
ESL629	Lever	17.4 - 43.4	1.96 - 4.90	1000	1/4" hex
ESL629P	Push	17.4 - 43.4	1.96 - 4.90	1000	1/4" hex
Dimensions (mm): 278(L) x 39.5(dia)			Weight: 0.8 kg		

⁽¹⁾ ESD Safe housing available - add suffix '-ESD'



TOP CONNECTION
ADD SUFFIX '-U'

ESP6 Pistol Grip tools come standard with the cable connection at the bottom of the handle - top rear cable connection is optional. An accessory side handle is included with each tool.

ESP6 Brushless Pistol Grip Drivers					
Model Number ⁽¹⁾	Start Type	Range (In.Lbs)	Range (Nm)	Speed (RPM)	Drive Type
Pistol Grip Body Style					
ESP635	Trigger	18 - 53	2 - 6	1000	1/4" hex
ESP635-SQ	Trigger	18 - 53	2 - 6	1000	3/8" square
ESP645	Trigger	27 - 79	3 - 9	800	1/4" hex
ESP645-SQ	Trigger	27 - 79	3 - 9	800	3/8" square
ESP655	Trigger	36 - 106	4 - 12	550	1/4" hex
ESP655-SQ	Trigger	36 - 106	4 - 12	550	3/8" square
ESP665	Trigger	53 - 159	6 - 18	350	1/4" hex
ESP665-SQ	Trigger	53 - 159	6 - 18	350	3/8" square
Dimensions (mm): 270(L) x 169(H) x 48(dia)			Weight: 1.2 kg		

⁽¹⁾ Pistol Grip tool has cable connection in bottom of handle as standard. For top rear connection, add suffix 'U' to model number.



ESL6_M Series Screwdrivers incorporate an aluminum front collar to facilitate fixture mounting and include an accessory side handle for handheld applications.

ESL6_M Handheld / Fixture Mount					
Model Number	Start Type	Range (In.Lbs)	Range (Nm)	Speed (RPM)	Drive Type
Inline Body Style, Handheld or Fixture Mount					
ESL635M	Lever	18 - 53	2 - 6	1000	1/4" hex ⁽¹⁾
ESL635PM	Push	18 - 53	2 - 6	1000	1/4" hex ⁽¹⁾
ESL645M	Lever	27 - 79	3 - 9	800	1/4" hex ⁽¹⁾
ESL645PM	Push	27 - 79	3 - 9	800	1/4" hex ⁽¹⁾
ESL655M	Lever	36 - 106	4 - 12	550	1/4" hex ⁽¹⁾
ESL655PM	Push	36 - 106	4 - 12	550	1/4" hex ⁽¹⁾
ESL665M	Lever	53 - 159	6 - 18	350	1/4" hex ⁽¹⁾
ESL665PM	Push	53 - 159	6 - 18	350	1/4" hex ⁽¹⁾
Dimensions (mm): 297(L) x 46.2(dia)			Weight: 1.25 kg		

⁽¹⁾ Standard bit holder is 1/4" hex quick change type.
For optional 3/8" square drive, add suffix '-SQ'

40VDC Series drivers are capable of developing high torques - side handles are included where suitable. We recommend mounting in a torque reaction arm for ultimate ergonomics and operator safety. See pages 26-27 for torque arms.

The Delta Regis ESL6_M/RA 90° Angle Driver combines the standard ESL6_M inline driver with a premium quality 3/8" square drive angle head attachment for high torque performance and access to tight areas.



FRONT END OF ESL6_M/RAS 90° ANGLE DRIVER WITH OPTIONAL SWIVEL BAIL

ESL6_M/RA Right Angle Drivers					
Model Number ⁽¹⁾	Start Type	Range (In.Lbs)	Range (Nm)	Speed (RPM)	Drive Type
Right Angle Head Driver, 3/8" square drive, optional swivel bail					
ESL635M/RA	Lever	28 - 71	3.2 - 8	625	3/8" square
ESL645M/RA	Lever	42 - 106	4.8 - 12	500	3/8" square
ESL655M/RA	Lever	57 - 142	6.4 - 16	340	3/8" square
ESL665M/RA	Lever	85 - 212	9.6 - 24	220	3/8" square
Dimensions (mm): 422(L) x 46.2(dia)			Weight: 2 kg		

⁽¹⁾ An optional Swivel Tool Bail is available for hanging the Angle Driver from a balancer. Add suffix 'S' (eg. ESL635M/RAS) for tool with swivel bail.

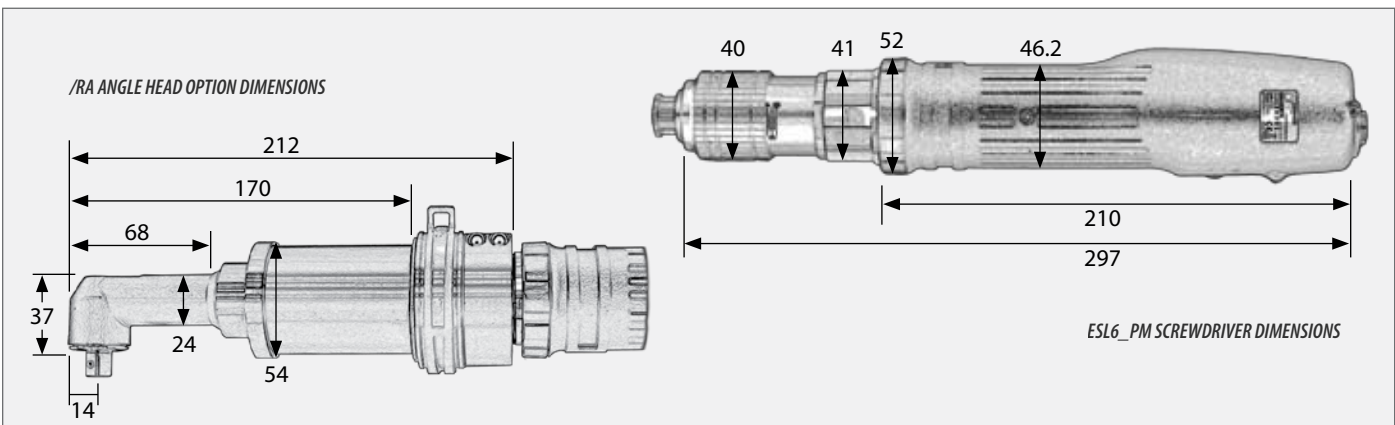

Controller model BECT640HL provides the power required to run all models of high torque 40V DC Brushless Series Screwdriver. This includes tool models ESL628(F/P/PF) thru ESL665M(PM) and models ESP635-665. CE/RoHS/ETL Approved.



BECT640HL
HI/LO SPD CONTROLLER



ECT6-SSOB
SLOW-START
MODULE

Power Supplies / Controllers								
Model Number	Outlets	Speeds	Tool Connector	Output	Input	Dimensions L x W x H (mm)	Weight (kg)	Use only with Screwdriver Models
BECT640HL	1	Hi/Lo	6 pin	40/30VDC, 220W	100-240VAC, 6.3A	210 x 118 x 85	1.8	All 40V DC Brushless

Power supply shipped with standard North American cordset. For EU cord, add suffix 'E'; for UK cord, add suffix 'UK'.

The ECT6-SSOB control module adds "Adjustable Slow-Start" and "Output Signal" capability to a 40VDC brushless tool. This control module plugs in-line between the BECT640HL controller and any model of 40VDC brushless driver.

Model Number	Use with Controller Model	Slow Start Time	Slow Start Speed	Output Signals Available (Transistor-open collector)	Cable Length	Dimensions (mm)
ECT6-SSOB	BECT640HL	0.1 ~ 5 sec.	30-100% full spd	Run/Clutch/Reverse	0.3m	58 x 95 x 35

Accessories

Select driver model no. on the right, follow column down the chart; X signifies an appropriate accessory.

	ESL628 (F) ESL629	ESL628P (PF) ESL629P	ESL628 (F) - ESD ESL629 - ESD	ESL628P (F) - ESD ESL629P - ESD	ESL635M - 665M	ESL635PM - 665PM	ESP635 - 665	ESL635M / RA - ESL665M / RA	ICESL628 (F) - ESD ICESL629 - ESD	ICESL628P (F) - ESD ICESL629P - ESD
Torque Lock Sleeve - covers the torque adjusting nut to deter tampering (*1 included with 628/629 drivers)										
DR80-20142C (Clear) *	X	X								
DR80-20142E (ESD safe) *			X	X					X	X
DR80-20142M (Metal)	X	X	X	X					X	X
Pistol Grip Attachment - reconfigures an in-line screwdriver for horizontal fastener installation										
DR80-PG628/9	X									
DR80-PG628/9ESD			X							
DR80-PG628/9P		X								
DR80-PG628/9PESD				X						
Tool Holster - fasten to the edge of a workbench and park the screwdriver when not in use										
DR80-10136	X	X	X	X					X	X
Angle Head Attachment - 90 degree angle attachment for accessing tight spaces (lever start tools only)										
DR80-10160A	X		X						X	
Cable Assemblies - for use with all 40VDC ESL6/ESP6 Screwdrivers										
DR96-10016M	2m (6.5 ft), 6 pin, Standard Cable (included with each screwdriver)									
DR96-10018M	3m (9.8 ft), 6 pin, Optional Long Cable									
DR96-10018M/C	3m (9.8 ft), 6 pin, Coiled Cable with 0.4m whip ends									



For other accessories including balancers, support arms, screw feeders, and torque testers, see pgs 24-30

ICESL BRUSHLESS DRIVER with INTERNAL COUNTER

32V / 40VDC Brushless Motor

The Delta Regis ICESL Series tool integrates the performance of a DC Shut-Off Clutch Brushless Screwdriver with a programmable, handle-mounted Batch Counter. Each tool includes a 2m cable to connect to a 32V or 40VDC Power Supply (sold separately).

- Batch count value can be set from 0-99 screws/batch. Screwdriver will count down by one each time a good fastener rundown is completed.
- LED display shows current screw count value and displays the available options and setting values during programming mode.
- Programming buttons are located on the driver directly below the LED display. Buttons are used to set-up parameters prior to using the screwdriver for assembly. Programming mode can be locked by pressing a preset combination of buttons to avoid accidental program changes.
- 'Clear' button allows the count to be manually reset to begin a new batch.
- Min and max rundown time settings allow the user to establish an acceptable time window for fastener installation. Only fastener rundowns which occur within the specified window will be accepted as good (OK) and cause the count to increment. Rundowns completed outside the time window will be considered no good (NG). This might occur if the screw was cross-threaded (time too short - below min time) or stripped (time too long - greater than max time).
- Visual and audible indicators are available to let the operator know if the rundown was OK or NG, and when the batch has been completed.
- Screwdrivers can be hard-wired with additional output signal cable (included in box) to output rundown status (NG/OK Batch) to a PLC.



ICESL DRIVER WITH INTERNAL COUNTER

ICESL6 Drivers with Internal Counter								
Model Number	Start Type	Range In.Lbs	Range Nm	Speed (RPM) Hi / Lo	Length in / mm	Grip Dia. in / mm	Weight lbs / g	Use with Power Supply model
ICESL623-ESD	Lever	1.3 - 10.5	0.15 - 1.18	1000 / 700				BECT620C or BECT620IC (‘F’ fast tools) (see pg 9)
ICESL623P-ESD	Push	1.7 - 10.5	0.20 - 1.18	1000 / 700				
ICESL623F-ESD	Lever	1.3 - 10.5	0.15 - 1.18	2000	10.6 / 270	1.5 / 37	1.3 / 580	
ICESL623PF-ESD	Push	1.7 - 10.5	0.20 - 1.18	2000				
ICESL624-ESD	Lever	2.6 - 16.5	0.29 - 1.86	1000 / 700				
ICESL624P-ESD	Push	2.6 - 16.5	0.29 - 1.86	1000 / 700				
ICESL628-ESD	Lever	8.7 - 26.0	0.98 - 2.94	1000 / 750				BECT640HL (see pg 14)
ICESL628P-ESD	Push	8.7 - 26.0	0.98 - 2.94	1000 / 750				
ICESL628F-ESD	Lever	8.7 - 26.0	0.98 - 2.94	2000	11.6 / 294	1.6 / 40	1.8 / 820	
ICESL628PF-ESD	Push	8.7 - 26.0	0.98 - 2.94	2000				
ICESL629-ESD	Lever	17.4 - 43.4	1.96 - 4.90	1000 / 750				
ICESL629P-ESD	Push	17.4 - 43.4	1.96 - 4.90	1000 / 750				

COUNTING CONTROLLER - 40V / 32V BRUSHLESS DRIVERS

Fasten | Count | Verify

Add functionality and error-proofing to your Delta Regis Brushless Screwdriver with the BECT640-SSO Counting Controller. This controller offers a host of options including Slow Start, Batch Counting, and OK/NG Rundown Indication based on the screwdriving cycle occurring within a predefined time window. An externally accessible I/O connection provides the user with a signal interface. Outputs are available for rundown OK, rundown NG, and batch complete. External switches may be wired to the input for remote enable (part in position) and remote clear (reset batch count).

- Selectable **Slow Start** Speed and Time
- Large LED Display of Screw Count Values
- Externally Accessible **I/O Connections**
- **Programmable Batch Counting** with Audible Buzzer indicating batch complete
- **Programmable Time Window** for comparison with actual fastening cycle time - LED's indicate **OK/NG** rundown cycle
- Lock to limit access to program modifications
- Works with 40V and 32VDC Brushless Drivers (Optional adapter cable req'd for 32V tools)
- ETL / CE / RoHS Compliant



Counting Controller Model & Specifications

Model Number	Outlets	Speeds	Approvals	Output	Input	Dimensions L x W x H (mm)	Weight (kg)
BECT640-SSO	1	Hi/Lo	CE/RoHS/ETL	40/32/24V DC, 220W	100-240V AC, 6.3A	248 x 130 x 100	2.5
Use with driver models:		CESL610-612*, CESL623-624(P/F/PF)*, ESL628-629(P/F/PF), ESL629M-665M(PM), ESP620-665					

Power supply shipped with standard North American cordset. For EU cord, add suffix 'E'; for UK cord, add suffix 'UK'.
 * Optional DR96-40TO32V-WHIP cable required when using controller with 32VDC CESL610-624 Screwdrivers

Features	
Slow Start Time Adjustment	0 - 9.9 sec
Slow Start Speed Adjustment	30 - 100%
Count (per batch)	1 - 99
Time Window Setting Range (min/max)	0 - 9.9 sec
Audible Alert (selectable)	Good/NG/Batch OK

Inputs
1. Remote Enable
2. Clear (Reset) Batch Count

Outputs (NPN and relay)
1. Rundown OK
2. Rundown NG
3. Batch Complete

Inputs require an external switch (dry contact) only. A 12 VDC voltage supply is available to power the output circuit, if required.

BECT640-SSO Controller Overview

Parameters are set-up on the BECT640-SSO using the four button keypad and LED display panel. A simple program loop provides access to settings for slow start speed and time, batch count quantity, and min/max allowable rundown times. During normal operation, the large two-digit display shows the current screw count value and also provides visual LED indication of whether the rundown was Good or No Good based on the time window parameters that are programmed into the controller by the user.

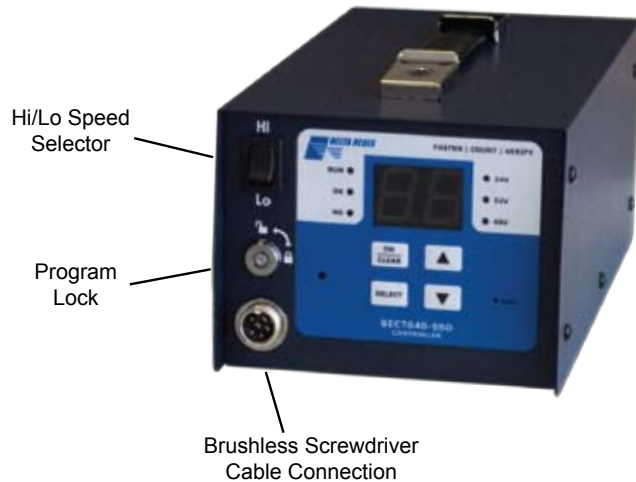
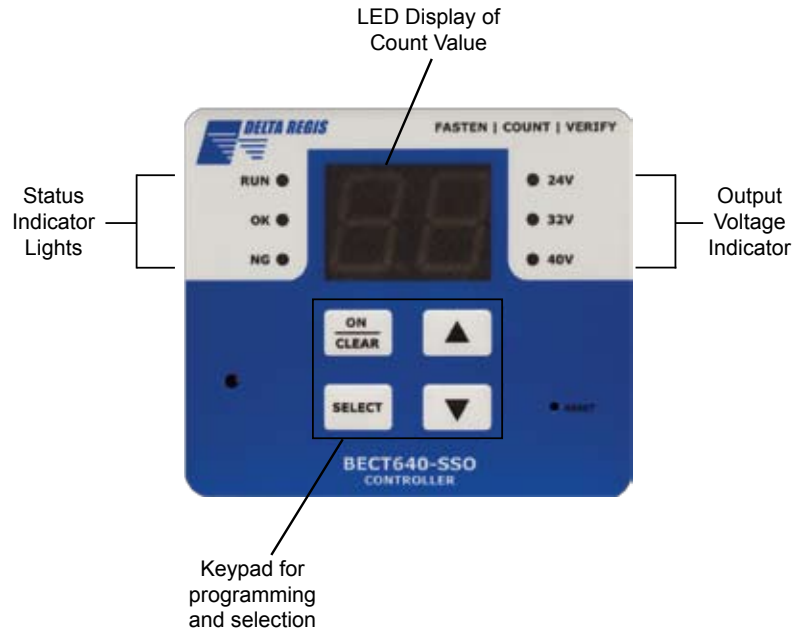

DIP Switch for optional functionality

Input / Output Connections:
 12VDC supply (if required to power external circuit)
 OK / NG / OK ALL (sinking outputs - 24VDC, 10mA max)
 OK / NG / OK ALL (dry contact outputs - 60V, 400mA max)
 ENABLE input (requires normally closed switch contact)
 CLEAR input (requires normally open switch contact)
 COM - 0VDC (supply, input and sinking output common)

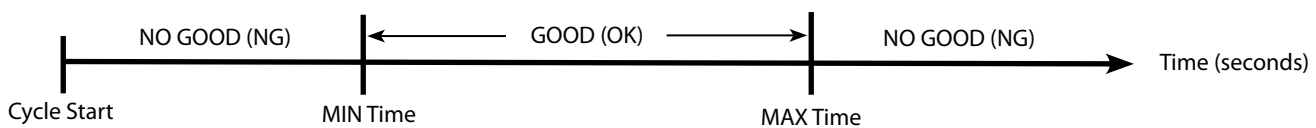

If the fastening cycle completes (clutch trips) within the programmed time window, the rundown cycle will be accepted as GOOD (OK) and the batch count will increment.

STANDARD DUTY 32V DC SHUT-OFF CLUTCH Electric Screwdrivers

Solid construction and innovative design are apparent everywhere on these tools. Accurate torque control and superb ergonomics make them perfect for electronic assembly. All models feature ESD safe housings and externally replaceable brushes. Fan equipped motors and flow through ventilation keep these tools running cool - increasing tool life and operator comfort. Our low torque models are some of the smallest and lightest available, making them well suited for precision assembly operations.

- Accurate Torque Control.
- Lockable Torque Adjustment - optional torque locking sleeve makes it easy to set up and secure.
- Wide Torque Range - single model versatility .
- Rare Earth Magnet Motor - high torque output .
- Low Torque Reaction.
- Compact - light and easy to handle.
- Ergonomic Design - soft cushioning in grip area ensures operator comfort and reduced fatigue.
- All models feature ESD safe housings.
- CE / RoHS Compliant.



32VDC Brush Motor Screwdrivers								
Model Number*	Start Type	Range In.Lbs	Range Nm	Speed (RPM) Hi	Speed (RPM) Lo	Length in / mm	Grip Dia. in / mm	Weight lbs / g
ESL310S-ESD	Lever	0.2 - 3.1	0.02 - 0.35	430	315	8.7 / 222	1.3 / 33	0.6 / 270
ESL310-ESD	Lever	0.2 - 3.1	0.02 - 0.35	1000	700			
ESL311-ESD	Lever	0.4 - 6.2	0.05 - 0.7	1000	700			
ESL312-ESD	Lever	0.9 - 8.8	0.1 - 1.0	670	470	9.1 / 230	1.46 / 37	1.1 / 480
ESL323-ESD	Lever	1.5 - 10.6	0.17 - 1.2	1000	700			
ESL323P-ESD	Push	1.5 - 10.6	0.17 - 1.2	1000	700			
ESL324-ESD	Lever	3 - 14	0.34 - 1.58	1000	700	10.2 / 260	1.5 / 38	1.3 / 600
ESL324P-ESD	Push	3 - 14	0.34 - 1.58	1000	700			
ESL327-ESD	Lever	6 - 21	0.69 - 2.37	750	520			
ESL327P-ESD	Push	6 - 21	0.69 - 2.37	750	520	10.6 / 269	1.6 / 41	1.6 / 700
ESL328-ESD	Lever	7 - 26	0.79 - 2.98	530	350			
ESL328P-ESD	Push	7 - 26	0.79 - 2.98	530	350			
ESL329-ESD	Lever	13 - 39	1.5 - 4.4	530	350	10.6 / 269	1.6 / 41	1.6 / 700
ESL329P-ESD	Push	13 - 39	1.5 - 4.4	530	350			

*To order screwdriver without ESD safe housing, drop suffix '-ESD' from model number.

Accessories

The ECT326 power supply / controllers act as AC to DC transformers and torque controllers. The electronic control circuit cuts the power to the motor in response to the clutch signal from the electric screwdriver. These units feature Hi/Lo or Variable speed selection. CE/RoHS/ETL approved.



ECT326 Controller

Model Number	Outlets	Speeds	Output	Input	Dimensions L x W x H (mm)	Weight (g)
ECT326	1	Hi/Lo	32 / 24V DC, 60W	100-240V AC	145 x 60 x 35	255
ECT326V	1	Variable	24 - 32V DC, 60W			

Power supply shipped with std North American cordset. For EU cord, add suffix 'E'.

Accessories	ESL310-ESD ESL310S-ESD		ESL311-ESD ESL312-ESD		ESL323-ESD ESL324-ESD		ESL323P-ESD ESL324P-ESD		ESL327-ESD ESL328-ESD		ESL327P-ESD ESL328P-ESD		ESL329-ESD		ESL329P-ESD	
	Select driver model no. on the right, follow column down the chart; X signifies an appropriate accessory.															
Torque Lock Sleeve - covers the torque adjusting nut to deter tampering																
DR80-10130														X		X
DR80-10130E (ESD safe)														X		X
DR80-10131									X		X					
DR80-10131E (ESD safe)									X		X					
DR80-10133C (Clear)	X		X													
DR80-10133E (ESD safe)	X		X													
DR80-10134C (Clear)					X		X									
DR80-10134E (ESD safe)					X		X									
Tool Holster - fasten to the edge of a workbench and park the screwdriver when not in use																
DR80-10135 (w/ lock sleeve)									X		X		X		X	
DR80-10136 (no lock sleeve)									X		X					
DR80-10136 (w/ lock sleeve)					X		X									
DR80-20135 (no lock sleeve)													X		X	
DR80-20136 (no lock sleeve)	X		X		X		X									
DR80-20136 (w/ lock sleeve)	X		X		X		X									
Angle Head Attachment - 90 degree angle attachment (lever start tools only)																
DR80-10160A									X					X		
DR80-10161A					X											
Cable Assemblies - for use with all 32VDC Brush Screwdrivers																
DR96-10016B	2m (6.5 ft), 6 pin, Standard Cable (included with each driver)															
DR96-10018	3m (9.8 ft), 6 pin, Optional Long Cable															
DR96-10020	6m (19.2 ft), 6 pin, Optional Long Cable															



For other accessories including balancers, support arms, screw feeders, and torque testers, see pgs 24-30

DIRECT PLUG-IN, SHUT-OFF CLUTCH 120 / 220V Electric Screwdrivers

Delta Regis ESL3 Series direct plug-in Electric Screwdrivers are specifically designed to meet the requirements of the industrial manufacturing market. Accurate torque control and a rubberized ergonomic grip make them an ideal solution for demanding production assembly applications. These units plug directly into an AC outlet, eliminating the need for an external power supply. Stepless torque adjustment in ranges starting from 0.15 to 4.4 Nm.

- Convenient Direct Plug-In Design - internal power and control circuitry allows driver to plug directly into 120V or 220VAC
- Once preset torque is reached, the screwdriver shuts off - the start mechanism must be reset to run again
- External Torque Adjustment Nut - easy to set up and secure with optional torque lock sleeve
- Ergonomic Design - soft cushioning in grip area ensures operator comfort and reduced fatigue
- Externally Replaceable Brushes for ease of maintenance
- 3m Power Cord with standard 3 prong grounded plug
- 1/4 inch hex quick change chuck allows rapid bit change
- Available in lever or push start models



120VAC SCREWDRIVER SPECIFICATIONS	
Input Voltage	110-120V AC, 50/60Hz
AC Plug Type	3 prong grounded
AC Current (no load)	0.3 - 0.4A
Bit holder	1/4" hex quick change



120V Shut-off Clutch Screwdrivers							
Model Number	Start Type	Range In.Lbs	Range Nm	Speed (RPM)	Length in / mm	Diameter in / mm	Weight lbs / g
ESL300	Lever	1.8 - 10.4	0.20 - 1.18	1000	9.5 / 242	1.5 / 38	1.2 / 550
ESL300P	Push	1.8 - 10.4	0.20 - 1.18	1000			
ESL301	Lever	2.5 - 16.5	0.29 - 1.86	1000			
ESL301P	Push	2.5 - 16.5	0.29 - 1.86	1000	10.6 / 269	1.6 / 41	1.6 / 700
ESL302	Lever	13 - 39	1.47 - 4.41	500			
ESL302P	Push	13 - 39	1.47 - 4.41	500			

The 220V AC direct plug-in 380 Series Electric Screwdrivers are designed to meet the needs of the European industrial market. These tools have the same basic features and benefits as the 120V models with the addition of CE/ RoHS Compliance and a 3m cord with standard Euro plug.

220VAC SCREWDRIVER SPECIFICATIONS	
Input Voltage	220-240V AC, 50/60Hz
AC Plug Type	Euro Plug
AC Current (no load)	0.4A
Bit holder	1/4" hex quick change

220V Shut-off Clutch Screwdrivers							
Model Number	Start Type	Range In.Lbs	Range Nm	Speed (RPM)	Length in / mm	Diameter in / mm	Weight lbs / g
ESL383E	Lever	4.4 - 19	0.49 - 2.16	1000	10.6 / 269	1.6 / 41	1.6 / 700
ESL383PE	Push	4.4 - 19	0.49 - 2.16	1000			
ESL383FE	Lever	3.5 - 15	0.39 - 1.67	1900			
ESL383PFE	Push	3.5 - 15	0.39 - 1.67	1900			
ESL384E	Lever	8.8 - 26	0.98 - 2.94	700			
ESL384PE	Push	8.8 - 26	0.98 - 2.94	700			
ESL384FE	Lever	8.8 - 26	0.98 - 2.94	1000			
ESL384PFE	Push	8.8 - 26	0.98 - 2.94	1000			
ESL385E	Lever	13 - 39	1.47 - 4.41	500			
ESL385PE	Push	13 - 39	1.47 - 4.41	500			

Standard tool supplied with EU plug on power cord - for UK plug, add suffix '-UK'

Accessories	ESL300		ESL301		ESL300P		ESL301P		ESL302		ESL302P		ESL383E		ESL383FE		ESL384E		ESL384FE		ESL385E		ESL383PE		ESL383PFE		ESL384PE		ESL384PFE		ESL385PE	
	ESL300	ESL301	ESL300P	ESL301P	ESL302	ESL302P	ESL383E	ESL383FE	ESL384E	ESL384FE	ESL385E	ESL383PE	ESL383PFE	ESL384PE	ESL384PFE	ESL385PE																
Select driver model no. on the right, follow column down the chart; X signifies an appropriate accessory.																																
Torque Lock Sleeve - covers the torque adjusting nut to deter tampering																																
	DR80-10130				X	X	X	X	X	X	X	X	X	X	X	X	X	X	X	X	X	X	X	X	X	X	X	X	X	X	X	X
	DR80-10130M (Metal)				X	X	X	X	X	X	X	X	X	X	X	X	X	X	X	X	X	X	X	X	X	X	X	X	X	X	X	X
	DR80-10134C (Clear)		X	X																												
	DR80-10134M (Metal)		X	X																												
Tool Holster - fasten to the edge of a workbench and park the screwdriver when not in use																																
	DR80-10135 (w/ lock sleeve)				X	X	X	X	X	X	X	X	X	X	X	X	X	X	X	X	X	X	X	X	X	X	X	X	X	X	X	X
	DR80-10136 (w/ lock sleeve)		X	X																												
	DR80-20135 (no lock sleeve)				X	X	X	X	X	X	X	X	X	X	X	X	X	X	X	X	X	X	X	X	X	X	X	X	X	X	X	X
	DR80-20136 (no lock sleeve)		X	X																												
Angle Head Attachment - 90 degree angle attachment (lever start tools only)																																
	DR80-10160A				X						X	X	X																			
	DR80-10161A		X																													

For other accessories including balancers, support arms, screw feeders, and torque testers, see pgs 24-30

DIRECT PLUG-IN, SLIP (RATCHET) CLUTCH 120V Electric Screwdrivers



Delta Regis ESL5 Series Slip Clutch direct plug-in Electric Screwdrivers are an economical solution for general assembly. Perfect for box build and self tapping applications, these units plug directly into a 120V AC outlet eliminating the need for an external power supply. Stepless torque adjustment in ranges starting from 0.44 to 39 in.lbs and speeds from 500 to 1200 RPM.



- Convenient Direct Plug-In Screwdrivers - built-in AC to DC rectifier allows screwdrivers to plug in directly to a 120V AC outlet (220V AC available).
- Clutch slips once the pre-set torque is reached.
- Well suited for tapping screw applications.
- Ergonomic Design - slim ergonomic grip for operator comfort.
- Externally replaceable brushes.

120VAC SCREWDRIVER SPECIFICATIONS	
Input Voltage	110-120V AC, 50/60Hz
AC Plug Type	3 prong grounded
AC Current (no load)	0.3 A
Bit holder	1/4" hex quick change

120V Slip Clutch Screwdrivers							
Model Number	Start Type	Range In.Lbs	Range Nm	Speed (RPM)	Length in / mm	Diameter in / mm	Weight Lbs / g
ESL500LT	Lever Start	0.44 - 6.1	0.05 - 0.69	1200	9.1 / 230	1.4 / 36	1.1 / 480
ESL500	Lever Start	1.8 - 13	0.20 - 1.47	1200			
ESL501	Lever Start	4.4 - 21.6	0.49 - 2.45	1000	10.4 / 264	1.5 / 38	1.3 / 600
ESL502	Lever Start	8.8 - 30	0.98 - 3.40	700			
ESL503	Lever Start	13.2 - 39	1.47 - 4.41	500			

Accessories	Select driver model no. on the right, follow column down the chart; X signifies an appropriate accessory.				
	ESL500LT	ESL500	ESL501	ESL502	ESL503
 Torque Lock Sleeve - cover for the torque adjusting nut					
DR80-10131			X	X	X
DR80-10132	X	X			
 Tool Holster - fasten to the edge of a work bench to park driver					
DR80-10135 (w/ lock sleeve)			X	X	X
DR80-20135 (no lock sleeve)			X	X	X
DR80-20136	X	X			

For other accessories including balancers, support arms, screw feeders, and torque testers, see pgs 24-30

Manual Torque Screwdrivers

SERIES 7400 TORQUE SCREWDRIVERS

More and more screw connections in service and industry have to be tightened to a prescribed torque. Only the exact torque guarantees a secure fastening as well as a fast and easy loosening.

Our adjustable models can be adjusted in fine increments allowing for controlled tightening. Preset models come preset to their lowest setting and can be changed within their available torque range.

- Ergonomic handle provides better turning power with less effort resulting in more power and speed with less operator fatigue.
- Quick change bit holder accommodates insert and power bits.
- Accuracy is +/- 6% (complies with EN ISO 6789).
- Calibration certificate provided with each tool.
- 1/4" Hex Drive.

Model Number	Type	Style	Range	Graduations
DR95-A7440M	Adjustable	Straight	0.3-1.2 Nm	0.05 Nm
DR95-A7441M	Adjustable	Straight	1.2-3.0 Nm	0.10 Nm
DR95-A7442PM	Adjustable	Pistol	3.0-6.0 Nm	0.25 Nm
DR95-A7445	Adjustable	Straight	2.5-11.5 in.lbs	0.5 in.lbs
DR95-A7446	Adjustable	Straight	11-29 in.lbs	1.0 in.lbs
DR95-A7447P	Adjustable	Pistol	25-50 in.lbs	2.5 in.lbs
DR95-P7465	Preset	Straight	2.5-11.5 in.lbs	-
DR95-P7466	Preset	Straight	11-29 in.lbs	-
DR95-P7467P	Preset	Pistol	25-50 in.lbs	-



SERIES 1000 TORQUE SCREWDRIVERS

Whether the need is for preset torque screwdrivers for the assembly line or adjustable ones for field maintenance, the compact precision and versatility of our screwdrivers provides the ability to assure quality on an ongoing basis.

- Clutch releases automatically when preset torque is attained - no over torquing.

- Anti-backlash design for repeatability.
- Can be used in both right and left hand directions.
- Accuracy of +/- 6% Indicated Value meets or exceeds ANSI B107.14M and ISO 6789.
- Comes with free NIST traceable certification.
- 1/4" Hex Drive.

Model Number	Type	Style	Range	Graduations
DR95-10002	Adjustable	Straight	15 - 74 cNm	1 cNm
DR95-10003	Adjustable	Straight	20 - 100 in.oz	1 in.oz
DR95-10006	Adjustable	Straight	2 - 36 in.lbs (0.2 - 4.0 Nm)	2 in.lbs (0.2 Nm)
DR95-10004	Preset	Straight	20 - 100 in.oz (15 - 74 cNm)	-
DR95-10005	Preset	Straight	3 - 15 in.lbs (0.34 - 1.7 Nm)	-
DR95-10007	Preset	Straight	7 - 36 in.lbs (0.8 - 4.0 Nm)	-



DRFF PRECISION SCREW FEEDER for 1.0-5.2mm dia. screws

The Fast Feed 520 utilizes a precision feed system suitable for almost any type of screw. The Fast Feed 520 also features three adjustments giving the user superb control over feed speed and time. Thanks to the superior design of the rail, it can be easily adjusted to feed screw sizes from 1.0 to 5.2 mm.

- One rail to accommodate many screw sizes
- Multiple adjustments = Optimized feed rate
- Less moving parts increases the durability
- Low maintenance / Easy to service
- Quiet operation



Specifications	
Model Number	DRFF-520
Screw Thread Diameter	1.0-5.2mm (#0-#10)
Max. Screw Length	19mm (0.75 in)
Dimensions L x W x H	183 x 125 x 142 mm
Weight	2.5 kg
Accessories (included)	
AC Adapter, Rail Adjustment Kit, Manual	



Because the hopper supplies a large quantity of screws to the rail and the rail feeds the screws smoothly, the screw replenishment rate is fast enough to keep up with the quickest operators.

Each DRFF-520 Screw Feeder includes a step-by-step quick start guide with illustrations to simplify the set-up process.



Rail adjustment kit

The DRFF-520 is compact and lightweight. The feeder costs only a fraction of the price of a conventional bowl feeder. It features multiple adjustments to dial in the optimal feed rate including: Vibration Timer, Vibration Intensity, and Drum Timer.

These adjustments allow you to fine tune the unit to your specific application and screw type.



BENCH MOUNT TORQUE TESTER for calibration and verification

Set and verify the torque output of your electric screwdriver with the DRBT Series torque tester. It's bench mount design and wide torque measuring range make it well-suited for use in the production area, repair shop, or quality control lab. Two rundown joints and a battery charger are included with each DRBT tester. The entire package is housed in a protective carrying case and includes a certificate of calibration.

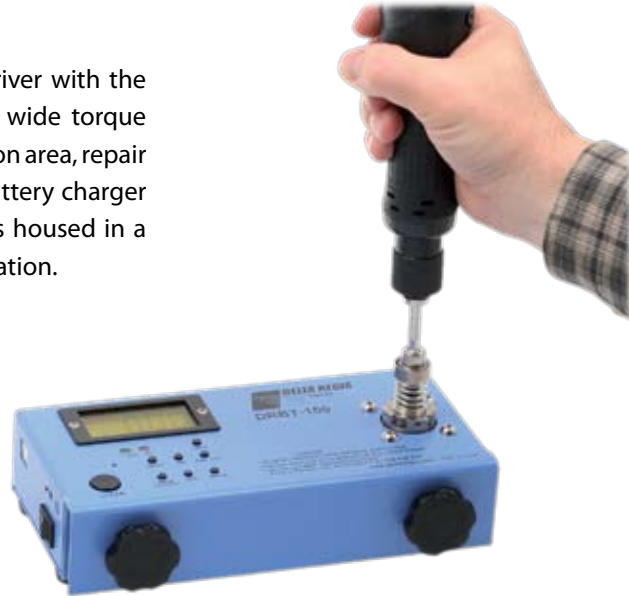

Important Features of the DRBT Series

- Wide torque measuring range
- Accuracy of +/- 0.5% from 20-100% of full scale
- Selectable measuring units - Kgf.cm, Nm, Lbf.in
- Track, Peak, and Initial Peak measuring modes
- Store up to 800 torque readings, output data via on-board USB connection (cable not included)
- Selectable auto-zero function to clear display automatically after a preset time of between 0.5-3.0 seconds
- User entry of hi/lo torque limits - in peak mode, the tester will compare the rundown torque to the set limits and indicate either Good (green led) or NG (red led)
- Display Statistics - Min, Max, and Average torque for the last group of rundowns (up to 30 data points)
- Internal rechargeable battery pack. Charge time less than 8 hrs, Run time approx 30 hrs at full charge
- Not for use with impact tools



Specifications		
Model Number	DRBT-10	DRBT-100
Torque Range	0.15-10 Kgf.cm	1.5-100 Kgf.cm
	0.015-1.000 Nm	0.15-10 Nm
	0.15-9.00 Lbf.in	1.5-90 Lbf.in
Accuracy (20-100% FS)	+/- 0.5% I.V.	
Dimensions L x W x H (mm)	230 x 123 x 65	
Weight (kg)	2.0	
Accessories (included)		
AC Adapter ⁽¹⁾	120 VAC Input 7.2VDC, 120mA Output	
Rundown Joints Included ⁽²⁾		
DRBT-10	JS-03 (0.3Nm) and JS-1A (1Nm)	
DRBT-100	JS-1B (1Nm) and JS-5 (5Nm)	

⁽¹⁾ Add suffix 'E' for 220VAC EU Adapter

⁽²⁾ An optional 10 Nm capacity joint (JS-10) is available

ERGO-12 TELESCOPIC TORQUE REACTION ARM

The ERGO-12 Telescopic Reaction Arm is used to absorb and transfer the reaction force generated at the screwdriver during fastening, without having a significant effect on freedom of movement, thereby reducing operator fatigue. Through the use of carbon-fiber tubes, the arm is extremely tough while being light at the same time. With the universal mounting adapter, the ERGO-12 is capable of being mounted problem-free in most work areas.

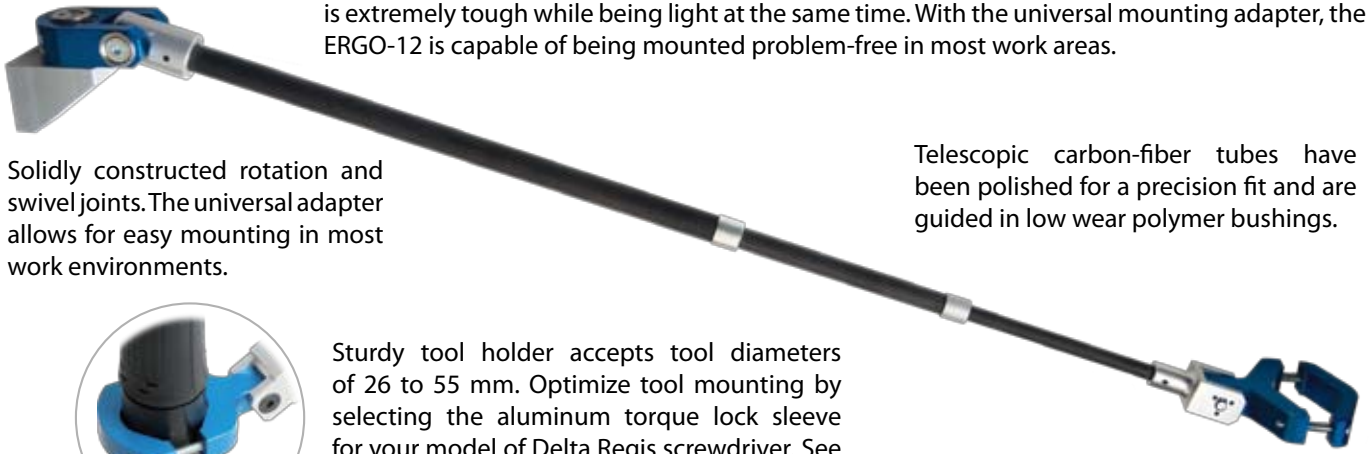

Solidly constructed rotation and swivel joints. The universal adapter allows for easy mounting in most work environments.

Telescopic carbon-fiber tubes have been polished for a precision fit and are guided in low wear polymer bushings.



Sturdy tool holder accepts tool diameters of 26 to 55 mm. Optimize tool mounting by selecting the aluminum torque lock sleeve for your model of Delta Regis screwdriver. See following page for further details.

Telescopic Arm Model Number	Max. Torque in-lb / Nm	Max. Work Radius in / mm	Min. Work Radius in / mm	Fits Tool Diameter in / mm	Weight lbs / kg
ERGO-12-L-HZ	106 / 12	37.8 / 962	20.3 / 515	1.0 - 2.1 / 26 - 55	1.3 / 0.57
ERGO-30-L-HZ	265 / 30	37.8 / 962	20.3 / 515	1.0 - 2.1 / 26 - 55	1.5 / 0.68

DR90-20004 ECONOMY TORQUE REACTION ARM

Reduce employee injury by absorbing torque transmission, eliminating repetitive strain on hands, wrists and arms. These arms are capable of supporting tools up to 5 lbs (2.27 kg) while withstanding torque reaction up to 20 ft-lbs (27 Nm).

Two versions are available to suit either pneumatic tool or electric tool mounting. The DR90-20004P has a 1/4" npt threaded female port for mounting an in-line air tool vertically using a pipe nipple. The DR90-20004E includes an electric tool adaptor to provide for clamping around the body of an electric screwdriver.

- Adjustable height. Parallel arm design maintains tool perpendicular to work surface.
- Tool weight is supported by a spring loaded arm assembly. Spring tension is adjustable.



DR90-20004E
Torque Arm

Part Number	Description
DR90-20004E	Torque Arm for Electric Screwdriver
DR90-20004P	Torque Arm for Pneumatic Driver
DR90-20002	Bench Clamp

ERGO-25 PRECISION PARALLEL TORQUE ARM

The ERGO-25 Parallel Torque Arm is designed to maintain a power tool in a vertical attitude. The pneumatic lift cylinder removes the weight of the tool from the operator's hand. Reaction torque is isolated from the operator and transferred through the base of the arm to the mounting surface. All pivot points combine tight machining tolerances with ball and needle bearings for precision and ease of motion.

- Precision arm designed to hold screwdrivers and tappers
- Perfect for higher torque Brushless Series screwdrivers
- Consistency of arm improves driver torque repeatability
- No torque reaction from the tool to the operator

Solid construction provides smooth arm movement. All moving axes equipped with ball and/or needle bearings.

Pneumatic cylinder supports the weight of the tool. Adjustable air pressure regulator varies lifting force. Non-return valve protects from sudden dropping. Requires compressed air supply.



Sturdy tool holder accepts tool diameters of 26 to 55 mm. Optimize tool mounting by selecting the aluminum torque lock sleeve that corresponds to your model of Delta Regis Electric Screwdriver.

For Tool Model:	Use Lock Sleeve:
ESL310/311/312	DR80-10133M
(C)ESL323/324/623/624/300/301	DR80-10134M
ESL327/328	DR80-10131M
ESL329/302/383-385	DR80-10130M
ESL628/629	DR80-20142M

Model	Height	Stroke vertical	Work radius	Torque max.	Tool Weight max.	Accepts Tool Diameter	Torque Arm Weight
	in / mm	in / mm	in / mm	ft-lb / Nm	lb / kg	in / mm	lb / kg
ERGO-25	23 / 584	17.9 / 456	31.5 / 800	18.5 / 25	4.4 / 2.0	1.0-2.2 / 26-55	16 / 7.2
ERGO-25-4	23 / 584	21.6 / 550	31.5 / 800	18.5 / 25	8.8 / 4.0	1.0-2.2 / 26-55	21 / 9.5

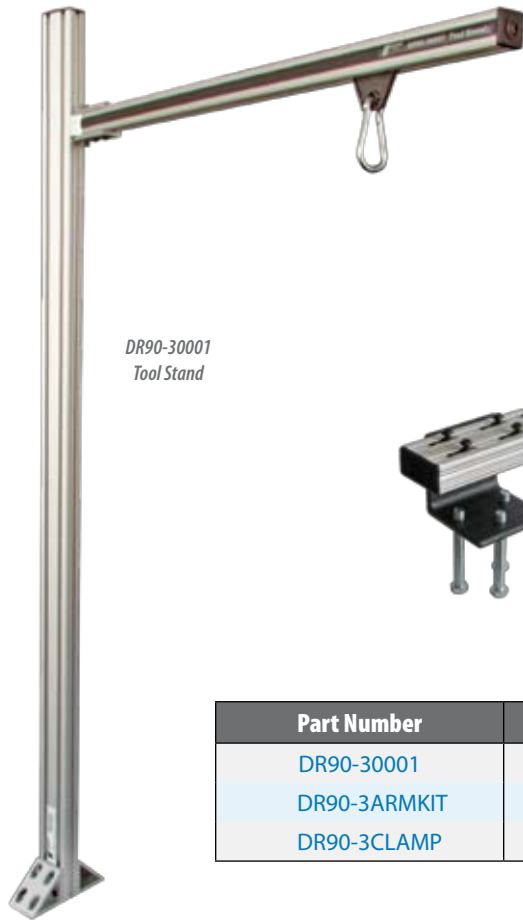

DR90-30001
Tool Stand



DR90-3CLAMP



DR90-3ARMKIT
Extra Arm Kit (includes slider and hanger)

DR90-30001 TOOL STAND

Using a tool balancer in conjunction with a tool stand will keep your screwdriver at the ready, leaving your work area clear when not in use. The DR90-30001 tool stand fastens directly to your workbench (screws req'd). An optional extra arm kit can be used to suspend two tools from the same stand.

Part Number	Description
DR90-30001	Tool Stand - 110 cm high, 60 cm reach, 4 kg maximum load
DR90-3ARMKIT	Extra Arm Kit - 60 cm reach, includes slider and hanging clip
DR90-3CLAMP	Bench Clamp - Fastens stand to edge of workbench, no drilling req'd



DR90-10103
Balancer



DR90-10104
Balancer

TOOL BALANCERS

Using a tool balancer in conjunction with a tool stand will keep your screwdriver at the ready, leaving your work area clear when not in use. Our tool balancer has a tension adjustment to accommodate different sizes of tools.

Part Number	Description
DR90-10101	Tool Balancer - 0.23 - 0.68 kg (0.5 - 1.5 lbs), 1.8m (6') travel
DR90-10103	Tool Balancer - 0.68 - 1.36 kg (1.5 - 3.0 lbs), 1.8m (6') travel
DR90-10105	Tool Balancer - 1.36 - 2.27 kg (3.0 - 5.0 lbs), 1.8m (6') travel
DR90-10104	Economy Balancer - 0.6 - 1.5 kg (1.3 - 3.3 lbs), 1.8m (6') travel

ERGO-SYS TOOL SUPPORT SYSTEM



For excellent tool support combined with tool torque reaction capability, choose the Delta Regis ERGO-SYS Tool Support System. Each system includes the following:

- (1) DR90-30001 Tool Stand
- (1) ERGO-12-L-HZ Torque Reaction Arm
- (1) DR90-1010_ Tool Balancer*



Sturdy tool holder accepts tool diameters of 26 to 55 mm. Optimize tool mounting by purchasing the optional aluminum torque lock sleeve that suits your screwdriver model.

For Tool Model:	Use Lock Sleeve:
ESL310/311/312	DR80-10133M
(C)ESL323/324/623/624/300/301	DR80-10134M
ESL327/328	DR80-10131M
ESL329/302/383-385	DR80-10130M
ESL628/629	DR80-20142M

*Select the system with the balancer that best suits the weight of the tool being supported. Optional metal lock sleeve and tool stand bench clamp can be purchased as separate accessories if required. (Screwdriver not included).

System Part No	Includes Balancer	Supports Tool Weight
ERGO-SYS-1	DR90-10101	0.5 - 1.0 lbs
ERGO-SYS-3	DR90-10103	1.0 - 2.5 lbs
ERGO-SYS-5	DR90-10105	2.5 - 4.5 lbs

SCREWDRIVER VACUUM PICKUP ATTACHMENT

Need to hold a non-ferrous fastener with the bit of your electric screwdriver? The Delta Regis Vacuum Pickup Attachment is a miniature, bit-mounted vacuum nozzle. The vacuum attachment is held on the screwdriver bit by a collet appropriately sized for the shank diameter of the bit. This allows for initial positioning of the pickup nozzle relative to the tip of the screwdriver bit. The nozzle tip is spring loaded and has a small amount of linear travel. The head of the screw seals up against the end of the nozzle and the nozzle rotates with the screw and driver bit. The outer collar of the attachment remains stationary and connects to a vacuum supply.



VACUUM PICKUP ATTACHMENT WITH DRIVER BIT

The vacuum pickup attachment is ordered as an assembly complete with the required screwdriver bit. The nozzle which seals the vacuum against the fastener rotates with the screw head and driver bit. The table below outlines options to specify a model number for the assembly. Please note that the bit types and nozzle configurations shown below cover the most common applications. Please contact us for information on other bit types or special nozzle configurations.

Model #

VACPU H70PH1 30 A M2

Material Code	Nozzle Material
A	Aluminum
B	Brass
S	Stainless

Code	Bit Type	Length (mm)	Replacement Bit Part #	Bit Tip Dia (mm)	Bit Shank Dia (mm)	Collet Dia Code
H70PHX	PH #00	70	DR91-1202XRD-A	2	3	30
H70PH0	PH #0	70	DR91-12020RD-A	2.5	3	30
H70PH1	PH #1	70	DR91-12021RD-A	2.5	3	30
H70PH2	PH #2	70	DR91-12022RD-A	3	4	40
H70TX5	TX5	70	DR91-135171	3	3	30
H70TX6	TX6	70	DR91-134740	3	3	30
H70TX8	TX8	70	DR91-060098	3	3	30
H70TX10	TX10	70	DR91-060100	4	4	40
H70TX15	TX15	70	DR91-060105	4	4	40
H70TX15	TX15	70	DR91-060105	4	4	40

Nozzle Code	Length (mm)	OD (mm)	ID (mm)
'M' Nozzles require min. 70mm bit length			
M0	10	6.4	3.2
M1	10	6.4	4
M2	10	6.4	4.5
M3	10	8	5
M4	10	8	6.4

Select a nozzle with an ID at least 1mm larger than the bit tip diameter. Nozzle ID must be smaller than the screw head OD.

DR80-VACPUMP VACUUM GENERATOR ASSEMBLY

The DR80-VACPUMP acts as a vacuum source for the VACPU assembly. The vacuum generator operates on a compressed air supply and includes an ON/OFF slide valve and a pressure regulator to adjust the vacuum flow. 2.5m (8 ft) of 6mm OD tubing is included to connect the VACPUMP to the fitting on the vacuum pickup attachment. Air Supply requirements: 1 SCFM, 45-90 psig, 1/4" npt inlet port



SCREWDRIVER BITS AND BIT HOLDERS

Delta Regis offers a comprehensive selection of Screwdriver Bits, Nutsetters, and Bit Holders. Due to the extensive range of product, we have chosen to maintain an updated PDF list of available accessory bits on our website at www.deltaregis.com/Accessories/Driver_Bits.

We offer bits in standard 1/4" hex drive for screws with Phillips, Slot, Torx, Square and Socket heads. A limited selection of bits with 4mm and 5mm round shank (winged) drive are also available. Magnetic and non-magnetic Nutsetters and Bit Holders of various lengths and configurations are available to suit specific application requirements. Minimum purchase quantities may apply, depending on the item.

Please give us a call or send us an e-mail if you require an accessory item that you don't see listed on our website or in our catalog. We'll be glad to try and assist you in getting the proper accessory to use with your Delta Regis screwdriver.



TORQUE CONVERSION FACTORS

oz-in	lb-in	lb-ft	Kg-cm	Nm
oz-in x 0.0071 = Nm	lb-in x 0.1130 = Nm	lb-ft x 1.356 = Nm	kg-cm x 0.01 = kg-m	Nm x 0.1020 = kg-m
oz-in x 0.0007 = kg-m	lb-in x 0.0115 = kg-m	lb-ft x 0.1383 = kg-m	kg-cm x 13.89 = in-oz	Nm x 10.197 = kg-cm
oz-in x 0.0720 = kg-cm	lb-in x 1.152 = kg-cm	lb-ft x 13.826 = kg-cm	kg-cm x 0.868 = in-lb	Nm x 141.60 = oz-in
oz-in x 0.0625 = lb-in	lb-in x 16.0 = oz-in	lb-ft x 192 = oz-in	kg-cm x 0.0723 = lb-ft	Nm x 8.851 = lb-in
oz-in x 0.0052 = lb-ft	lb-in x 0.08333 = lb-ft	lb-ft x 12 = lb-in	kg-cm x 0.098 = Nm	Nm x 0.7376 = lb-ft

Contact us:

DELTA REGIS TOOLS, INC
3315 Industrial 25th St
Ft. Pierce, FL 34946
USA

Ph 1-888-500-2755 or 772-465-4302
Fx 1-866-500-7270 or 772-465-4368

e-mail: sales@deltaregis.com
website: www.deltaregis.com

In Europe, contact:

DELTA REGIS TOOLS GmbH
Wolfgangshof 4
82140 Olching
Germany

Ph +49 (0) 89 899621-50
Fx +49 (0) 89 899621-99

e-mail: info@deltaregis.eu
website: www.deltaregis.eu

SCREW FEEDERS ■ ASSEMBLY TOOLS ■ TORQUE TESTERS ■ TOOL SUPPORTS ■ SCREW FEEDERS ■ ASSEMBLY TOOLS ■ TORQUE TESTERS

